

Bachelor Thesis

Grindability analysis of dental core build-up materials under clinically relevant test procedure

TENGGU IBRAHIM MAULANA¹¹Section Medical Materials Science and Technology, University Hospital Tübingen, Osianderstr. 2-8, 72076 Tübingen, Germany

Date of the Bachelor's degree (Medical Engineering) June 27, 2016

Objective. Endodontically treated teeth often suffers a lack of coronal tooth structure, so that adding a suitable core build-up material is required, before the abutment tooth preparation and crown reconstruction can be performed. The core build-up material is the fundamental part of the load bearing structure of the tooth. Therefore, it needs to possess adequate mechanical and physical properties and has to support and protect the residual tooth structure before the final restauration. The grindability behavior of the core materials is one of the important aspects for a successful crown placement, which was specifically tested under clinical conditions and analyzed in this study. Dentin is the natural core material found in the teeth, so the similarity of core build-up materials to dentin in terms of their mechanical characteristics is an important consideration. The present study deals with the grindability characteristics of several different materials. Their similarity to dentin characteristics was then analyzed.

Methods. The glass ionomer cement used in this study was Ketac Fil, and the resin composites were LuxaCore Smartmix Dual, Visalys Core, Rebuilda DC, MultiCore Flow, Core Paste XP and Core-Flo DC. Dentin specimens were used as control group. The study consists of two phases, namely, the rough-cutting phase and the polishing phase, all simulating clinical conditions. The rough-cutting phase was performed under three different press forces of 0.5 N, 0.85 N and 1.2 N, using medium-grit size (106–125 μm) diamond burs attached to dental handpiece with 200,000 min^{-1} rotation speed under 50 ml/min water cooling. The generated material depths of each material were then measured and compared to those of dentin. The polishing phase was performed under 0.5 N press force using fine-grit size (46 μm) diamond burs with rotational speed of 150,000 min^{-1} under the same water cooling rate as the previous phase. The surface roughness of each material were then measured and compared to those of dentin. The statistical analysis of one-way ANOVA with Dunnett's post test was performed

Results. Results showed statistically significant differences ($p < 0.05$) of removal depths between Ketac Fil and dentin under 0.5 N, 0.85 N and 1.2 N press forces. Luxacore Smartmix also displayed significant differences ($p < 0.05$) under 0.85 N and 1.2 N press forces, while Core-Flo DC exhibited significant differences only under 1.2 N press force. Visalys Core, Rebuilda DC, MultiCore Flow and Core Paste XP maintained their removal depth similarity to dentin by showing no significant differences on every adjusted press force. The surface roughness between dentin specimens, Visalys Core and Luxacore Smartmix are pretty similar, and there was no significant difference, while Ketac Fil, Core Past XP and Core-Flo DC showed a statistically significant difference to dentin ($p < 0.05$).

Conclusions. Overall, Visalys Core and Rebuilda DC exhibited the greatest similarity to dentin in terms of grindability behavior, whereby the polymer component and chemical bond between fillers and polymers could play a significant role. Visalys Core has better surface roughness and showed no inhomogeneous structure. © 2017 Journal of Medical Materials and Technologies

Keywords: dentin, core built up material, grindability, material removal, surface roughness.

<http://dx.doi.org/10.17441/medmat.v1i1.12>

INTRODUCTION

Endodontically treated teeth often suffers a lack of coronal tooth structure, which generally caused by decay, excessive wear or previous restorations [24]. With this significant coronal substance loss, adding a suitable core build-up material is required, before the abutment tooth preparation and crown reconstruction can be performed [21]. Since the core is the fundamental part of the load bearing structure of the tooth, core build-up material not only needs to possess adequate mechanical and physical properties to resist occlusal forces, it also has to support and protect the residual tooth structure before the final restoration [2, 22]. Furthermore, the grindability behavior of the core materials during preparation has to be taken into consideration for a successful crown placement [17, 19, 29].

Presently, four chemically different groups of alloplastic materials are commonly used as core build-up materials, as an alternative to the traditional materials such as amalgam and gold alloys. These include reinforced glass-ionomer cements (GIC), resin-modified glass-ionomers (RMGIC), compomers (polyacid-modified composites) and composite resins (CR) [2].

Until late 1990s, zinc phosphate cement and glass ionomer cement were generally recommended for the core build-up material [23]. However, the insufficient chemical bond to the tooth enamel and particularly inadequate mechanical strength are considered to be the main problems with these materials [5]. The use of compomers (polyacid-modified composites) as core build-up material is also very popular among dental practitioners. However, hygroscopic expansion of the material can lead to crack formation in ceramic caps [28].

Such deficiencies on mechanical property can be avoided by using composite resin-based core build-up materials. Resin cements possess high tensile, compressive strengths and high bond strengths to both tooth structure and porcelain, which offers an alternative in the restorative dentistry [2, 23, 32]. However, further clinical study regarding other mechanical and chemical behaviors is still required.

General requirements for core build-up materials

The resistance of masticatory forces, biocompatibility, and also the similarity in their appearance, physical and mechanical properties to natural tooth structures, are some of the fundamental requirements for any dental material used in the oral cavity [31].

For core material in particular, it should possess an adequate compressive and flexural strength (FS) to provide stability against intraoral forces, hence avoiding core fracture or even displacement after the treatment [2]. Apart from sufficient bond strength between core materials and tooth structure, the applied core build-up material also needs to bond effectively to pins or posts, considering the frequent combination between these materials in clinical practice [19]. To restore all the primary functions of the

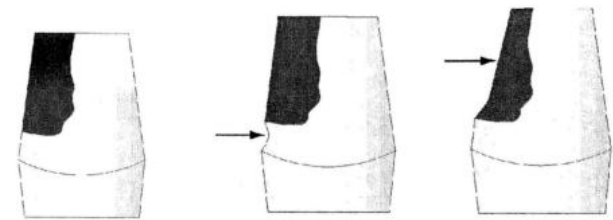

(a) Core build-up material (black) has the same grindability behavior like dentin (white).
 (b) Core build-up material (black) is harder than dentin (white).
 (c) Core build-up material (black) is softer than dentin (white).

Fig. 1. Grindability characteristics [17].

lost tooth structure, core build-up material has to produce tight sealing on the dentin wound for protection against thermal, chemical, and bacterial irritation [29].

Besides replacing enough missing tooth structure with adequate mechanical properties, the main objective of core build-up is to enable the creation of ideal retention and resistance form during crown preparation. To allow a reliable definitive restoration placement, the core build-up material needs to be prepared into the desired shape. For this reason, the core build-up material used has to possess a dentin-similar characteristic in terms of grindability and surface roughness in order to ensure a steady material removal during preparation Fig. 1a [20] and also a steady retention of the restoration. An unsteady material removal occurs when the core build-up material is either harder or softer than dentin, which either makes the crown placement difficult Fig. 1b or forms an unstable seat of the crown Fig. 1c [17].

Core build-up materials

Glass ionomer cement (GIC)

Glass ionomer cements were introduced nearly 40 years ago, and continue to play an expanding role in the restoration of teeth [32]. It consists mainly of inorganic fluoroaluminosilicate (FAS) glass powder, water, polyacid and tartaric acid [10], which cures by an acid-base reaction. On the recent glass ionomer cements-products, the liquid content is modified by reducing the viscosity, resulting in a slower curing-process [17].

There are some favorable and important properties that makes glass ionomer cements attain their clinical success, including their ability to bond to tooth structure [6], release fluoride for preventing the growth of bacteria and caries development [7], dentin-similarity of coefficient of thermal expansion (CTE) [4] and a wide range of clinical applications such as lining, basing and filling [26].

However, glass ionomer cements present some physical disadvantages compared with other core build-up materials, including low diametral and compressive strength, insufficient abrasion resistance, marginal instability under stress and brittle nature, thus limiting their use to low-stress areas [5, 14, 17]. These features should play a role

in the grindability characteristic of glass ionomer-based materials.

Resin-modified glass ionomer cement (RMGIC)

The poor mechanical properties of conventional glass ionomer cements can be improved by adding hydrophilic monomers and polymers such as hydroxyethylmethacrylate (HEMA) to its main components, with resin ratio ranges from 4 to 6% [11], resulting in what is called resin-modified glass ionomer cements (RMGIC). RMGICs set after chemical- or light initiation that triggers resin polymerization, after which a following acid-base reaction occurs for further hardening [11].

The flexural strength of this material is much higher than the conventional glass ionomer cements (roughly 71 MPa vs 11 MPa) and it also has a better wear resistance, higher fracture toughness and a longer working-time, as studies showed [11, 34]. Nevertheless, some disadvantages in this material still remain, such as their lower strength compared to tooth structure, lack of translucency and high rate of shrinkage, makes it only suitable as fillers [2].

Composite resin

In general, a composite material is a mixture of two different classes of materials, which generate a material with properties superior to those of the individual components. In dentistry, the composite is commonly made up of specific polymer (resin) matrix and inorganic particles (fillers) such as glass and/or silica, bound by silane coupling agent.

Fillers The main objective of adding filler materials is not only to increase the mechanical strength, but also to reduce the monomer content and therefore polymerization shrinkage, thermal expansion, translucency, radiopacity thus diagnostic sensitivity, surface roughness, along with improving aesthetics and handling properties [12]. The particle size of the fillers plays a significant role in the material strength, and is constantly decreasing over the years, from the traditional to the nano-composite materials [8]. The conventional resin composite (macroparticle > 10 µm) has initially a smooth surface with its organic components exposed on the surface. However, through mechanical and chemical activities in oral cavity, this outer layer becomes abraded, making the underlying fillers exposing themselves to the surface. As a result, the fillers will determine the surface roughness and consequently decide the material characteristics [18]. Although smaller filler particles provide a better surface roughness, they would not essentially enhance the handling and mechanical properties, because an increase in fillers-surface area to volume ratio has delimited the achievable filler loading [8].

In attempt to combine the desired strength and surface roughness, hybrid composite has been developed, mixing the smaller and the larger fillers together. The larger filler particles provide strength, when the smaller particles contribute to better aesthetics and wear. Nevertheless,

the term 'hybrid' is no longer used nowadays, considering that nearly all dental composites are 'hybrids' with a variety of particle sizes [12].

There are several classifications of composites based on their fillers, mainly being determined by the mean particle size or the amount of the fillers in volume per cent, providing a distinct clinical indication for the current composites in the market [12]. Based on their particle size, dental composites are categorized into traditional macrofilled composites with larger filler particles (10–100 µm), nanofillers (0.005–0.1 µm), microfillers (0.01–0.1 µm), minifillers (0.1–1 µm), fine fillers (0.1–10 µm), midfillers (1–10 µm) and lastly microhybrid filler as a mixture of microfine particles and fine particles [1, 2].

The shape of the fillers also does influence the composite characteristics, mainly divided into splintered pre-polymerized particles, spherical pre-polymerized particles and agglomerated microfiller complexes [16]. The spherical fillers have a higher wear rate, despite their ability to fill the composite in a higher amount than the irregular fillers of the same size [12]. Depending on the clinical use necessary, the recommended class of composite differs also (see Table 1).

Table 1. Classification of resin-based composites and indications for clinical use [1].

Class of Composite	Particle Size	Clinical Use
Traditional (large particle)	1–50 µm glass or silica	High-stress areas
Hybrid (midfilled)	(1) 0.1–10 µm glass, (2) 40 nm silica	High-stress areas requiring improved polishability (Classes III, IV)
Hybrid (minifilled/SPF*)	(1) 0.1–2 µm glass, (2) 40 nm silica	Moderate-stress areas requiring optimal polishability (Classes III, IV)
Homogeneous microfilled	40 nm silica	Low-stress and subgingival areas that require a high luster and polish
Heterogeneous microfilled	(1) 40 nm silica, (2) Pre-polymerized resin particles containing 40 nm silica	Low-stress and subgingival areas where reduced shrinkage is essential

Polymers and setting reaction During the development of composite resin industry and monomer chemistry, the addition of low molecular weight monomers as a 'diluting' agent including methyl-methacrylate (MMA), ethylenedimethacrylate (EDMA), triethylenglycol-dimethacrylate (TEGDMA) into the highly viscous conventional monomers such as bis-glycidly dimethacrylate (Bis-GMA) and urethane dimethacrylate (UDMA), is necessary to produce monomers with lower viscosity and therefore easier to blend and manipulate [2, 12]. It is observed that the improvement focuses on changing the dynamics of the

Table 2. Characteristics of some resins for provisional restorations [15].

Type	Advantages	Disadvantages	Brand	Manufacturer
Methyl-methacrylate	Good marginal fit, good transverse strength, good polishability, durable	High exothermic reaction, low abrasion resistance, high volumetric shrinkage	Alike™Jet	GC America Lang Dental
Ethyl-methacrylate	Good polishability, minimal exothermic reaction, good stain resistance, low shrinkage	Surface hardness, transverse strength, durability, fracture toughness	Snap®	Parkell
Bis-Acryl composite (self-cure or dual-cure depending on product)	Good marginal fit, low exothermic reaction, good abrasion resistance, good transverse strength, low shrinkage, dual-cure	Surface hardness, less stain resistance, brittle, thick oxygen-inhibited layer, not easy to repair	Luxatemp® Turbo Temp 2™ Protemp™ II	Zenith/DMG Danville Engineering 3M/Espe
Bis-GMA composite (dual-cure)	Good marginal fit, good polishability, very low exothermic reaction, good abrasion resistance, good transverse strength, very low shrinkage, repairable with flowable or direct composite	More expensive than methacrylate products	TempSpan®	Pentron Clinical Technologies
Bis-GMA composite (light-cure)	Good marginal fit, good polishability, low exothermic reaction, good transverse strength, low shrinkage, repairable/reline-able with flowable or hybrid composite, putty-like consistency (no mixing)	More expensive than methacrylate products, posterior teeth and cuspids only, single shade only	Protemp™ Crown	3M ESPE
Urethane Dimethacrylate (UDMA), chairside fabricated	Good marginal fit, good polishability, no exothermic reaction, good abrasion resistance, good transverse strength, very low shrinkage, light-cure, putty-like consistency (no mixing)	Not as esthetic as Bis-acryl or Bis-GMA materials, single shade only	Revotec LC	GC America

polymerization process, by modifying the formulations of Bis-GMA/TEGDMA or even developing an entirely new formulation such as tricyclodecane(TCD)-urethane based monomers, silorane-based monomers, dimer acid-based monomers and organically-modified ceramics (ormocers), to slow down the free-radical addition polymerization rate, thus reducing the material shrinkage [12]. Generally, the polymerization shrinkage increases proportional to the proportion of the 'diluting' monomers, generating a higher risk of leakage in marginal gaps [1].

Every resin used for dental composite has its own characteristic, some of them were documented in a study that reviewed some materials used for provisional restorations (Table 2) [15].

Dental resin composites are also classified into three groups based on their polymerization mechanism, namely self-cure (chemical-cure), light-cure and dual-cure, each having their own aesthetical, physical and biological advantages and disadvantages (Table 3). The reaction of the self-curing composite is initiated solely through mixing of two monomer pastes that contains initiator and co-initiator as an activator. Initially, the self-curing composites showed a few clinical problems such as inability to control working time of the mix and an increased air entrapment in the mixture, until the light-curing composites became available in the early 1970s [2].

The polymerization of the light-curing composite occurs inside the mouth of the patient and starts when the composite is exposed to light, which give the dentist more time to remove excess resin before curing, therefore reducing the finishing time [30]. The light-curing compos-

ite allows the use of only one paste, containing a combination of monomers, photo-initiator and co-initiator. Despite the excellent curing-controllability, the problem arises through the limited curing depth in this method, not to mention the necessity to match the lamp wavelength with the associated resin photo-initiation system [1]. However, the UV light-cured composites have been replaced nowadays by visible blue-light-activated systems with enhanced curing depth and a controllable working time [1].

Dual-cure resin composite enables the curing process to be both chemical and through light exposure. Hereby, the light accelerates the polymerization in upper layer, activating the photo-initiators in the resin, while the polymerization in the light-impenetrable area is purely chemical and sets up very slowly [18].

Compomer

Compomer is a polyacid-modified resin, in which the characteristics of glass ionomer cement and composite resin are merged. It consists of glass particles of glass ionomer cement (fluoroaluminosilicate) [2] and water-free monomer with acidic functional groups. The absence of water causes compomers not being self-adhesive, which makes it necessary to use a dentin-bonding agent before their placement [32]. The modification of the monomer takes place by adding polymerizable acid, that can cooperate in an acid-base reaction during the initial free-radical photopolymerization with appropriate initiator [1]. The addition of silicate glass particles is the driving force for the fluoride release, which is a particular characteristic for glass ionomer cement. It is caused by a slow acid-

base reaction between the acidic functional groups and glass particles, triggered by intraoral water intake from the saliva [1].

The hydrophilic resin matrix in compomers makes its water sorption rate (3.5% by weight) [1] higher compared to that of composites. This property assists a rapid compensation for polymerization-shrinkage of the composite matrix and thus provides lower marginal gap [32]. However, a 12-month clinical study has concluded that compomers used for core build-up possess the tendency to produce clinical failures of all-ceramic crowns, that is caused by an excessive hygroscopic expansion of the material [28].

The mechanical properties of compomers is generally better than those of GICs and RMGICs, but still inferior to those of composite resins [2, 18].

Core build-up materials grindability characteristics

Physical and mechanical properties of the material such as flexural strength, compressive strength, tensile modulus, thermal expansion and particularly hardness determine the grindability behavior of core build-up materials [29]. Hence, the factors that build these mentioned mechanical properties also play a significant role, such as chemical components and their inner bond strength, for example between polymer component and fillers in composite resin. The inferiority of mechanical properties of glass ionomer-based materials and polyurethane material towards resin composites or amalgam is known, such as inadequate bond strength to tooth structure and its brittle nature [5]. Consequently, this will lead to poor grindability behavior of these materials, which was proved in a study that identified the poor grindability characteristics of glass ionomer cements because of its massive material removal compared to dentin [17].

In contrast to glass ionomer cement-based material, composite resins generally exhibited better grindability behavior by having relatively similar material removal to dentin [17]. However, another study identified the various grinding efficiency value of different composite resins [25], although their surface roughness fulfilled the required range of value [29]. Moreover, there is still no study to test grindability behavior under different press forces, which occurs during dental practice.

In terms of surface roughness, the necessity to polish core build-up materials with fine-grit diamond burs to provide satisfactory surface roughness was concluded [17]. However, different conclusions for the surface roughness-similarity to dentin were found in different studies [17, 25, 29].

AIM OF THE STUDY

The aim of the following study is to analyze the grindability behavior of various core build-up materials that are available in the market and consequently to evaluate the dentin-similarity of the tested materials in terms of material removal and surface roughness. The material removal

and surface roughness are tested under standardized parameters such as press forces, bur speed, sufficient water cooling and rotational speed using fine- and medium-grit diamond burs, all simulating clinical condition.

The superior hardness of resin composites compared to glass ionomer cements are known. Therefore, the resin composites are expected to exhibit better dentin-similarity than the glass ionomer cements. The material composition will then be discussed, correlating with the results found in the experiments.

The main goal of this study is to provide a further clarity in which type of material the research and development of dental core build-up material should be concentrated.

MATERIAL AND METHODS

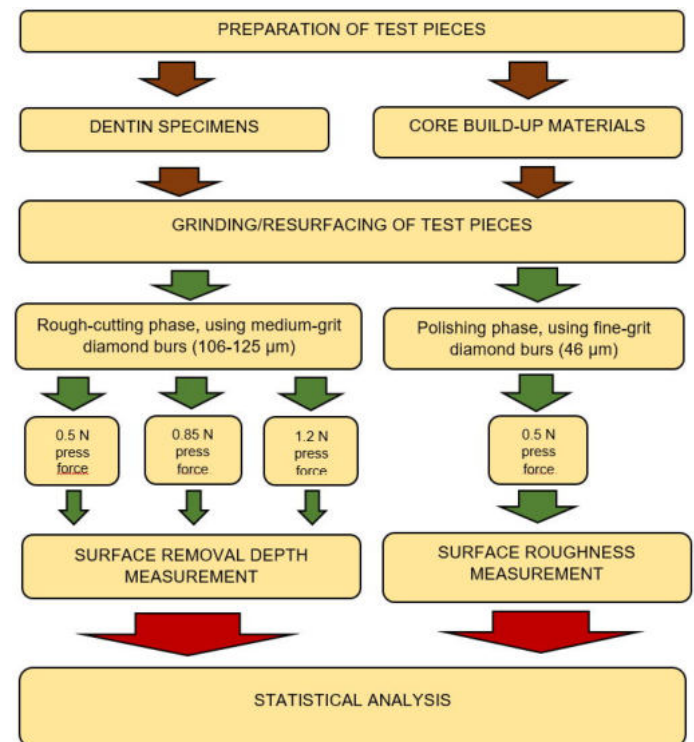

Fig. 2. Flow chart of the experiments.

Study design

Figure 2 explains the flow of the experimental chronology. Firstly, all the test pieces were prepared and shaped into the same dimension. Afterwards, they were inserted into a test piece holder before the cutting test starts. For coarse grinding test (mainly for material removal), medium-grit diamond burs were used by applying three different press forces. The fine-grit diamond burs were used by applying low press force to polish the material. Subsequently, the surface removal depth and surface roughness are measured and analyzed statistically.

Table 3. Resin cements according to their polymerization mechanisms [1, 30].

Resin cement	Characteristics	Indications	Advantages	Disadvantages
Self-cure	Useful in areas where light-curing is difficult	Endodontic posts, Ceramic restorations that prohibit curing unit from adequately polymerizing the resin cement	Convenience, no extra equipment needed, Marginal stress buildup during curing is much lower than for light-cured resins	Mixing causes air entrapment that weakens the material, Difficult to mix evenly, causing unequal degree of cure and consequent mechanical properties
Light-cure	working time, Decreased finishing time	Esthetic restorations, Cementing thin, translucent ceramic	Low porosity, thus stronger, Controllable working time	Limited cure depth, Higher marginal stress buildup, Special lamp is required
Dual-cure	Bond strength, Ease of use	Cementing thick, opaque ceramic	Assurance of a completion of cure	Porosity through air entrapment which weakens the material

Materials

The core build-up materials used in this study are based on conventional glass ionomer cement and composite resin. Dentin specimens were used as control groups. The list of materials can be seen in Table 4. The following are the product description and the recommended mixing procedure from the respective manufacturers:

Ketac Fil Plus is a glass ionomer filling material in capsules. Firstly, the capsule must be activated for 2 seconds by depressing the activator lever, then mixed at approximately 4,300 rpm with high frequency mixing device for 10 seconds. The material must then be applied within 1–2 minutes, which then sets in 7 minutes.

LuxaCore Smartmix Dual is an automixing, dual-cure composite resin. The product contains two main components that are mixed automatically within the mixing-tip of double syringe by applying constant pressure to extrude the material. The working time takes about 1–2 minutes, followed by self-curing reaction for approximately 5 minutes and light-curing for 20 seconds (layer ≤ 2 mm)/40 seconds (layer ≤ 4 mm) respectively.

Rebilda DC is also an automixing, dual-cure composite resin, which has the same mixing process as LuxaCore Smartmix Dual. The light-curing process with halogen light and the total working time takes about 40 seconds and 2 minutes, respectively. Without light-curing, the build-up can be finished 5 minutes after its application in the mouth. Core Paste XP, Core-Flo DC and MultiCore Flow also have an analogous mixing process to those of Luxacore Smartmix Dual and Rebilda DC. A minimum of 10–30 seconds is recommended for the light-curing process when using halogen light.

Visalys Core is an automixing, dual-cure, two-component system, fluoride-containing composite resin with unique Active-Connect-Technology (ACT) reportedly ensures a reliable bond with all common adhesives without an additional activator. The mixing process, working and curing times are analogous to those of LuxaCore, Rebilda DC, Core Paste XP, Core-Flo DC and MultiCore Flow.

All working times mentioned above apply at a room

temperature of 23 °C and a normal relative air humidity of 50 %. Lower temperatures extend and higher temperatures shorten these times.

Preparation of test pieces

Preparation of core build-up materials

For every core build-up material, 5 test pieces were prepared. Each material was then formed into 8 mm \times 4 mm dimensioned blocks that serves as test surface (Fig. 3).

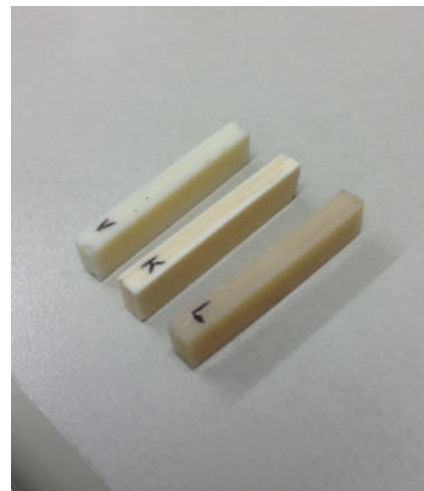
**Fig. 3.** Prepared core build-up materials in form of blocks.

The exact height of the test pieces is adjustable after they are mounted in the test piece holder manufactured for this study. The core build-up materials used in this study were shaped and provided by the manufacturer.

Preparation of dentin specimens

Twenty extracted permanent human mandibular molar teeth in similar size, that were previously stored in saline solution, were taken and cut using a diamond band saw (EXAKT 300 CL, Norderstedt) under water cooling to create 20 dentin specimens. The schematic illustration of the dentin preparation is shown on Figure 4a. The teeth crown was first removed, followed by sawing the surrounding

Table 4. Core build-up materials used in this study and their composition [3, 9, 33].

Material	Type of material	Material composition	Manufacturer
Dentin			
Ketac Fil Plus	Glass ionomer cement	Powder: lanthanum, aluminum, strontium fluorosilicate glass, and pigments Liquid: tartaric acid and water	3M ESPE Dental Products, Minnesota, USA
LuxaCore Smartmix Dual	Composite resin, dual-cured	Barium glass and pyrogenic silicic acid in a Bis-GMA based matrix from dental resins. Filler content: 72 % by weight = 49 % by vol. (0.02–2.4 μm)	DMG, Hamburg, Germany
Visalys Core	Composite resin, dual-cured with Active Connect Technology	Multifunctional acryl composite with 42 vol. % inorganic filler content (0.2–20 μm)	Kettenbach GmbH & Co. KG, Eschenburg, Germany
Rebilda DC	Composite resin, dual-cured	Bis-GMA, UDMA and TEGDMA based matrix with benzoylperoxide, silica, bariumborosilicate glass ceramic filler. Filler content: 71 wt % = 57 vol %. Filler size: mean 1.5 μm	VOCO GmbH, Cuxhaven, Germany
MultiCore Flow	Composite resin, dual-cured	Bis-GMA, UDMA and TEGDMA based matrix, barium glass, ytterbiumtrifluoride, Ba-Al-fluorosilicate glass and highly dispersed silicon dioxide. Filler volume: 70 wt % = 46 vol %. Filler size: 0.04 to 25 μm .	Ivoclar Vivadent, Schaan, Liechtenstein
Core Paste XP	Composite resin, dual-cured	Glass fillers in methacrylate resin NC wt % inorganic filler (NC = Data not collected)	DenMat, Santa Maria, California, USA
Core-Flo DC	Composite resin, dual-cured	Ethoxylated Bis A Dimethacrylate, Bis-GMA, silica, glass fillers Filler content: 50–75 wt %	BISCO, Inc., Schaumburg, Illinois, USA

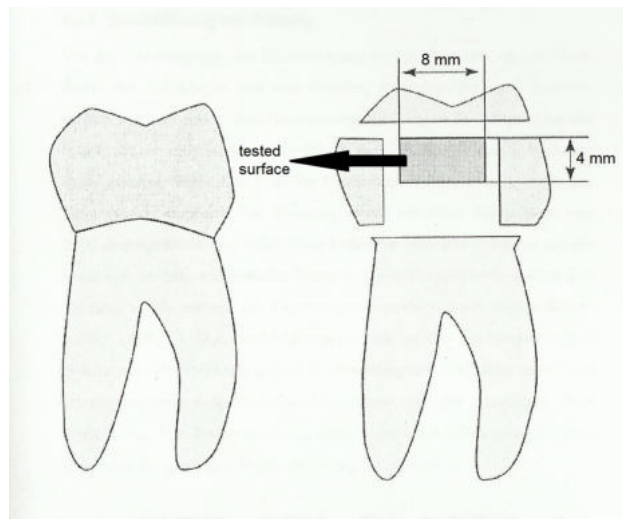
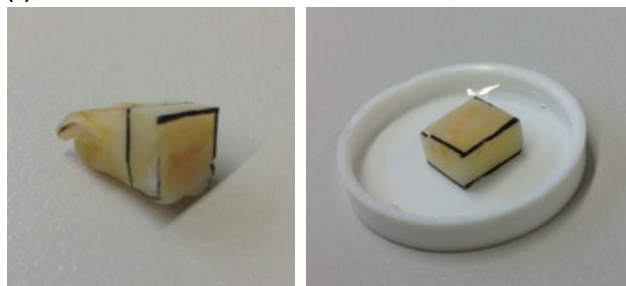
**(a)** Schematic illustration.**(b)** Dentin specimen with removed enamel.**(c)** Dentin specimen with removed enamel and root.**Fig. 4.** Preparation of dentin specimens.

dental enamel (Fig. 4b and 4c) until coronal dentin with the exact dimension of 8 mm \times 4 mm is produced. The maximum 4 mm width is intended for cutting out coronal dentin without entering the pulp chamber, where its presence could weaken the dentin specimen-structure and thus damage it under press force.

Methods

In accordance with the manufacturer's instructions, all testing specimens were stored in water at a room temperature of 23 $^{\circ}\text{C}$ for 48 h prior to the experiment.

All testing specimens prepared were then put next to each other into a test piece holder, exposing the 8 mm \times 4 mm surface on the top (Fig. 5).

This arrangement was designed to simulate the clinical condition where both core build-up material and dentin are cut in their axial plane. Due to insufficient length of the dentin specimens, they were glued to an unused core build-up material with a superglue. To prevent dislocation of the glued dentin during resurfacing, it was always mounted in the middle between the core build-up materials.

To simulate clinical condition, the experiment was conducted on dental chair (KaVo-ESTETICA[®] 1042) using a micromotor (INTRA K-LUX Motor 196)-driven angular handpiece (INTRAmatic lux 3 25 LH, transformation ratio 1:5), all from KaVo Dental GmbH, Biberach, Germany. The water flow rate was maintained constant for the entire test at 50 ml/min. As shown on Figure 6, the handpiece was attached on an axle bearing-rotational axis apparatus, by which the press force can be adjusted by changing the position of the back weight. A round bar and a hexagon

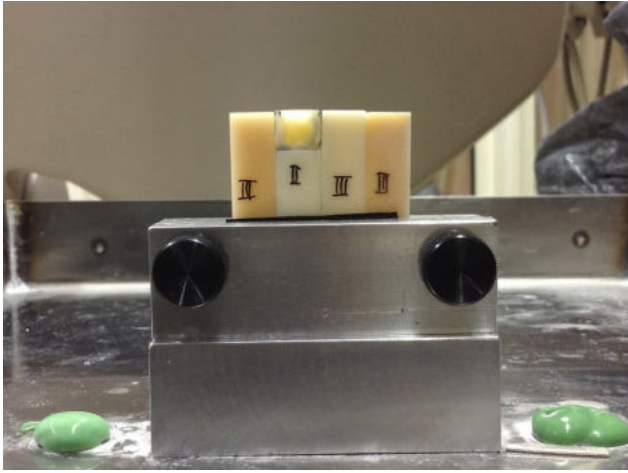

Fig. 5. Core build-up materials and dentin specimen were fixed on the test piece holder; from left to right: LuxaCore Smartmix, dentin specimen, Visalys Core and Ketac Fil.

nut were also attached to stop the rotational movement of this apparatus and consequently set the exact position of diamond bur parallel to the test surface. It is important to set the reference line, which will be explained later by the author. A hexagon nut was installed to give a maximum downward movement of the bur by 3 mm. This apparatus was then fixed on a multiphase motor-driven CNC three-coordinate table. The exact buildup can be seen on Figure 6.

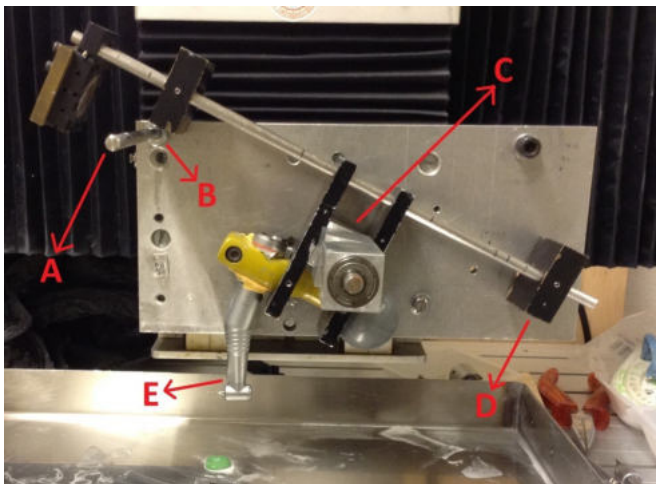
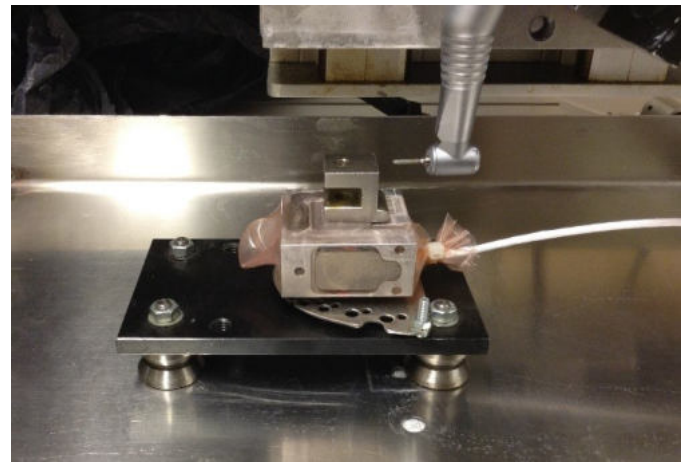

Fig. 6. A) round bar; B) hexagon nut; C) axle bearing-rotational axis apparatus; D) backweight; E) handpiece.

During the resurfacing, a computer software (WinPC-NC 2.00/45) controlled the three-coordinate table to move the handpiece with precise cutting speed and operational movement needed for each test. The grit-size of attached diamond bur was different depends on the phase of experiment, either cutting or polishing. Either way, the bur was always changed every 2 tests.

After the position of the back weight was fixed, the round bar was removed so the force on the bur tip can be

measured ten times before each test using 3-dimensional sensor (K3D40) and a software (GSVmulti 1.295), both from ME-Meßsysteme GmbH, Henningsdorf, Germany (Fig. 7a and 7b). The back weight position was changed until the desired press force was reached.



(a) Force on the bur tip measurement with 3D-sensor.

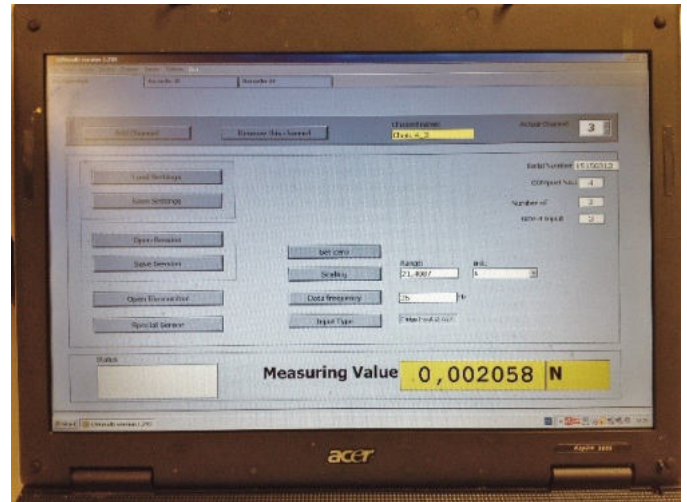

(b) GSVmulti 1.295 software, connected with 3D-sensor.

Fig. 7. 3D grinding force measurement.

The resurfacing test in this study consists of two phases, namely, the rough-cutting phase and the polishing phase. Each phase possess various parameters of press force, rotation speed, amount of grinding cycles and also different diamond burs.

Rough-cutting test

This phase simulates the initial preparation after core build-up material has been placed and cured, where dentist needs to remove the excessive material circumferentially with a diamond bur and simultaneously shape it into the required form with margins such as chamfer or shoulder. Medium-grit size (106–125 μm) diamond burs (Ref.Nr.: 6878 314 014, ISO-Nr.: 806 314 289534 014, Gebr. Brasseler GmbH & Co. KG, Lemgo, Germany) were used with rotational speed of $200,000 \text{ min}^{-1}$ and cutting

speed of 1.51 mm/sec. This phase was conducted at constant press forces of 0.5 N, 0.85 N and 1.2 N.

Firstly, the surface of all specimens were cut planar to set the reference line. The axle-bearing rotation apparatus was fixed on the round bar. After the reference line has been set, the hexagon nut was removed to give the axle-bearing apparatus free downward movement, thus activating the adjusted press force on the bur.

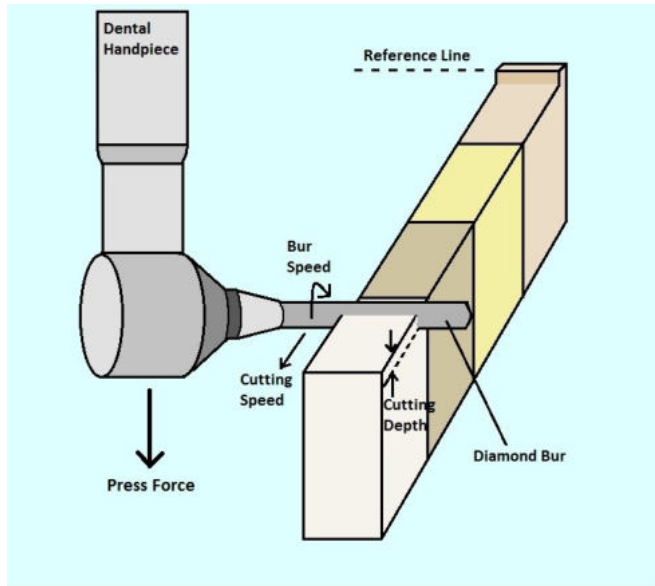

Fig. 8. Schematic representation of resurfacing of core build-up materials and dentin using a dental handpiece/bur.

The cutting movement was now set to grind only the middle area of the materials, leaving 2 mm edges both on the right and left side, so that the material removal depth can be measured afterwards. Each test consists of two grinding cycles. This test was conducted five times for every adjusted press force, with changing the materials ($n = 5$) and their sequence in each test. Schematic representation of the grinding process can be seen on Figure 8 and 9.

Surface removal depth measurement To measure the removal depth after grinding, the materials were photographed after each test using Canon EOS 700D (Canon Inc., Tokyo, Japan), magnified $7\times$ with microscope (Wild Macroscop M400, Wild Heerbrugg AG, Switzerland), which then measured using image processing software (Image-Pro Plus, Version 4.5.0.19, MD Rockville, USA) with tolerance of $\pm 10^{-3}$ mm by calculating the distance between reference line and material surface line (Figure 10).

All measurement data were documented using Excel 2013. The statistical analysis of one-way ANOVA with Dunnett's post test was subsequently performed using GraphPad Prism version 5.00 for Windows (GraphPad Software, San Diego California, USA). Dunnett's post test was performed to compare multiple results of the core build-up material to dentin's results.

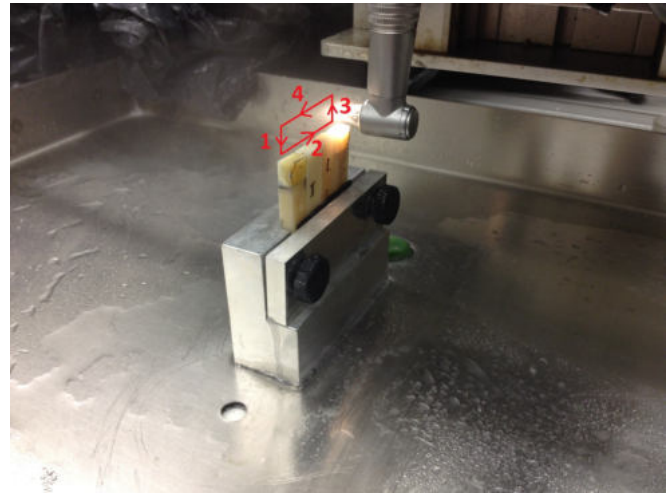

Fig. 9. Illustration of the grinding process. (1) Downward movement of the bur; (2) Surface grinding with the adjusted press force, bur speed and cutting speed. (3) Upward movement, first cycle is over. (4) Movement to the first position to repeat the grinding process.

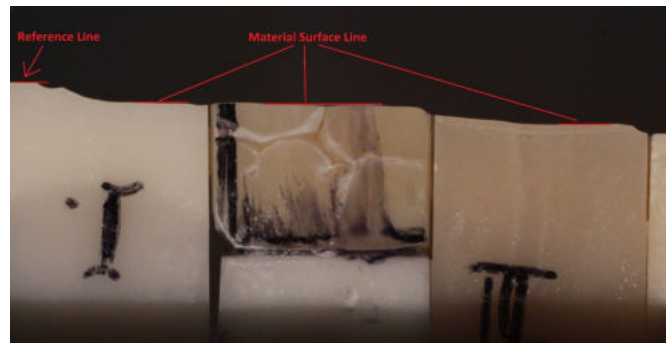

Fig. 10. The removal depth was measured by calculating the difference between the surface lines of each material and the reference line.

Polishing test

This phase simulates the finishing preparation after the excessive core build-up material has been removed. Fine-grit size $46\ \mu\text{m}$ diamond burs (Ref.Nr.: 8882L 314 014, ISO-Nr.: 806 314 143514 014, Gebr. Brasseler GmbH & Co. KG, Lemgo, Germany) were used with rotational speed of $150,000\ \text{min}^{-1}$ and cutting speed of 1.51 mm/sec. This phase was conducted under a constant press force of 0.5 N.

Firstly, the surface of all specimens were cut planar, merely to minimize the vertical movement of the bur during polishing. The axle-bearing rotation apparatus was fixed on the round bar. After the planar cut, the hexagon nut was removed to give the axle-bearing apparatus free downward movement, thus activating the adjusted press force on the bur tip. The material surface was then polished entirely, with only one grinding cycle for each test. The tests are repeated five times, changing the materials and their sequence in each test.

Surface roughness measurement The surface quality of each material was measured with a linear, electromechanical surface roughness measuring device (Perthen

Perthometer PRK, Messtechnik Lang, Weilheim-Teck, Germany), that operated by drawing a stylus at constant speed across 4 mm length of the surface in the polishing direction (Figure 11).

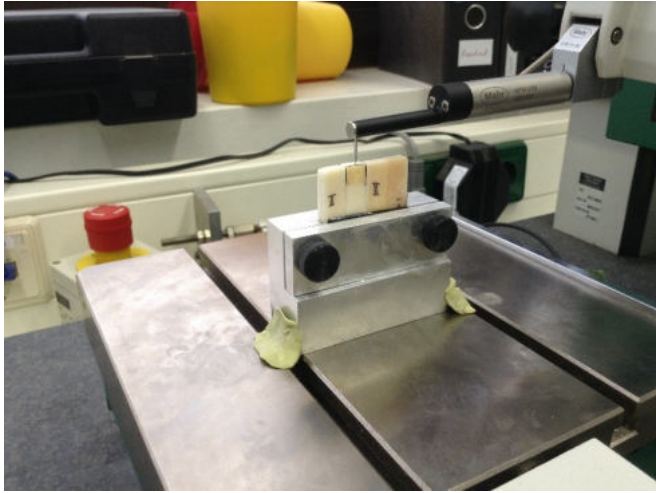

Fig. 11. Surface roughness of the materials was measured with a Perthometer by generating five measurement lines with a stylus instrument in contact mode.

Five measurement-lines were generated on each material, with distance of 0.6 mm between the lines. With 4 polished materials in each test, 20 roughness measurements were conducted in total.

For the statistical analysis, the three following roughness parameters were generated:

- The average roughness R_a , in accordance with ISO/DIS 4287-1. It is the arithmetic mean value of all profile deviations within the roughness reference path.
- Five point average roughness R_z , in accordance with ISO/DIS 4287-1. It is a parameter that averages the height of the five highest peaks plus the depth of the five deepest valleys within the roughness reference path. Therefore, extremes have a much greater influence on the final value.
- Maximum roughness R_{max} , in accordance with ISO/DIS 4287-1. It is the greatest distance between the highest peak and the lowest valley within the roughness reference path.

All measurement data were documented using Excel 2013. The statistical analysis of one-way ANOVA with Dunnett's post test was subsequently performed using GraphPad Prism version 5.00 for Windows (GraphPad Software, San Diego California, USA).

RESULTS

Rough-cutting measurement

In this segment, the materials were cut with medium-grit size (106–125 μm) diamond burs, rotating at 200,000 min^{-1}

with cutting speed of 1.51 mm/sec, under constant water cooling of 50 ml/min. Each test consists of two grinding cycles. The tests were conducted under 0.5 N, 0.85 N and 1.2 N of press force.

The material removal depths of dentin and core build-up materials were statistically analyzed and shown on Figure 12, 16, 20 and 24, with dentin specimens as the control group.

Under 0.5 N of press force

As shown on Figure 12, it is noticeable that Ketac Fil has much greater removal depth compared to dentin and the composite resins, and its mean value is approximately three times greater than that of dentin, which is significantly different ($p \leq 0.05$). For the composite resins, Core-Flo DC shows the most stable value distribution compared to others. It was also apparent that Rebuilda DC exhibited a highly similar removal depth's mean value to dentin, both with 0.236 mm and 0.222 mm, respectively. Luxacore Smartmix shows the largest mean value compared to other composite resins, but simultaneously has a highly similar value distribution to that of dentin. There is no statistically significant difference of material removal depths between all composite resins and dentin specimens. Better representation can be seen on Figure 13, 14 and 15. Figure 13 showed that the removal depths of Luxacore Smartmix, Visalys Core and dentin are relatively similar. Although Luxacore Smartmix displayed a slight waviness on Figure 14, its removal depth remained somewhat similar to Visalys Core, while Ketac Fil showed greater removal depth. Figure 15 showed the similar removal depths between Rebuilda DC, MultiCore Flow, Core-Flo DC and Core Paste XP. However, it is also visible that Rebuilda DC has a slightly less material removal compared to MultiCore Flow, Core-Flo DC and Core Paste XP.

Under 0.85 N of press force

By applying 0.85 N press force, it was apparent that the removal depth averages of Core-Flo DC, Visalys Core, Rebuilda DC, MultiCore Flow and Core Paste XP are relatively similar to that of dentin, with no significant difference to be found. Visalys Core has the most similar value to dentin, each at 0.516 mm and 0.487 mm. On the other hand, Rebuilda DC exhibited less material removal compared to dentin, with a material depth average of 0.431 mm. One composite resin, Luxacore Smartmix, has a higher average removal depth value than dentin at 0.766 mm, showing a nearly 0.3 mm gap. Results indicated a statistically significant difference ($p < 0.05$) at the 99.5% confidence level between Luxacore Smartmix and dentin. At the same confidence level, Ketac Fil also displays a significant difference to dentin, with an average removal depth of 0.914 mm, roughly 0.2 mm greater than Luxacore Smartmix. The mean removal depth value of Luxacore Smartmix is nearer to Ketac Fil's than to dentin's and any other composite resins. Between all test specimens, Ketac Fil presented the most stable value distribution, with

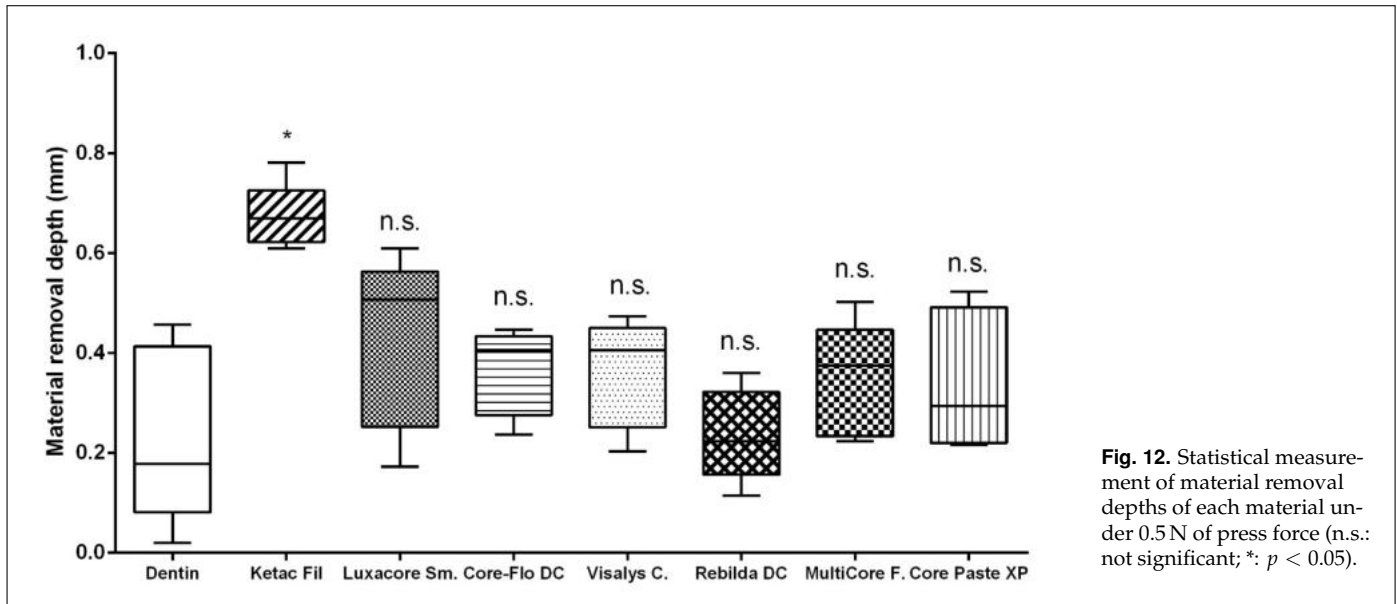

Fig. 12. Statistical measurement of material removal depths of each material under 0.5 N of press force (n.s.: not significant; *: $p < 0.05$).

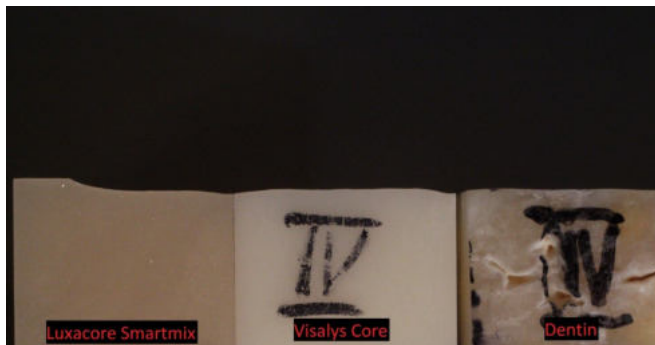

Fig. 13. Removal depths of Luxacore Smartmix, Visalys Core and dentin under 0.5 N of press force.



Fig. 14. Removal depths of Luxacore Smartmix, Visalys Core and Ketac Fil under 0.5 N of press force.

approximately 30% of the range of dentin. The statistical measurement is shown on Figure 16.

Better representations can be seen on Figure 17, 18 and 19. On Figure 17, the removal depths of Visalys Core and dentin are relatively at the same level, while Ketac Fil exhibited a slightly greater material removal. On another test row shown on Figure 18, difference on depth can also be identified, where Luxacore Smartmix presented more material removal in comparison to Visalys Core. Figure 19 showed that Rebilida DC has the least material removal depth compared to Core Paste XP, MultiCore Flow and

Core-Flo DC.

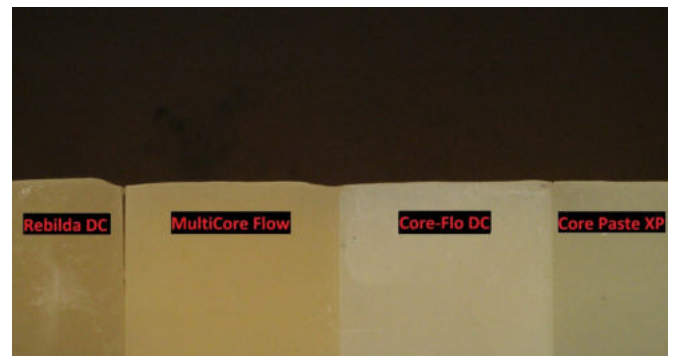

Fig. 15. Removal depths of Rebilida DC, MultiCore Flow, Core-Flo DC and Core Paste XP under 0.5 N of press force.

Under 1.2 N press force

The material depth results under 1.2 N press force indicate a significant difference ($p < 0.05$) between dentin and Luxacore Smartmix with more than 0.5 mm gap of removal depths, each possessed an average value of 0.760 mm and 1.268 mm. Another composite resin that exhibited a significant difference to dentin is Core-Flo DC with a mean value of 1.062 mm. On the other hand, Visalys Core, Rebilida DC, Core Paste XP and MultiCore Flow showed no significant difference ($p < 0.05$) to dentin. Visalys Core and Rebilida DC acquired 0.838 mm and 0.680 mm mean depth value, respectively, and obtained a relatively similar gap to dentin with only 0.08 mm, which is also the smallest gap compared to other core build-up materials. The statistical measurement is shown on the graph in Figure 20.

Figure 21 provides better illustration of the depth difference between Visalys Core, two different dentin specimens and Luxacore Smartmix that was photographed after the test. Visalys Core and dentin specimens showed

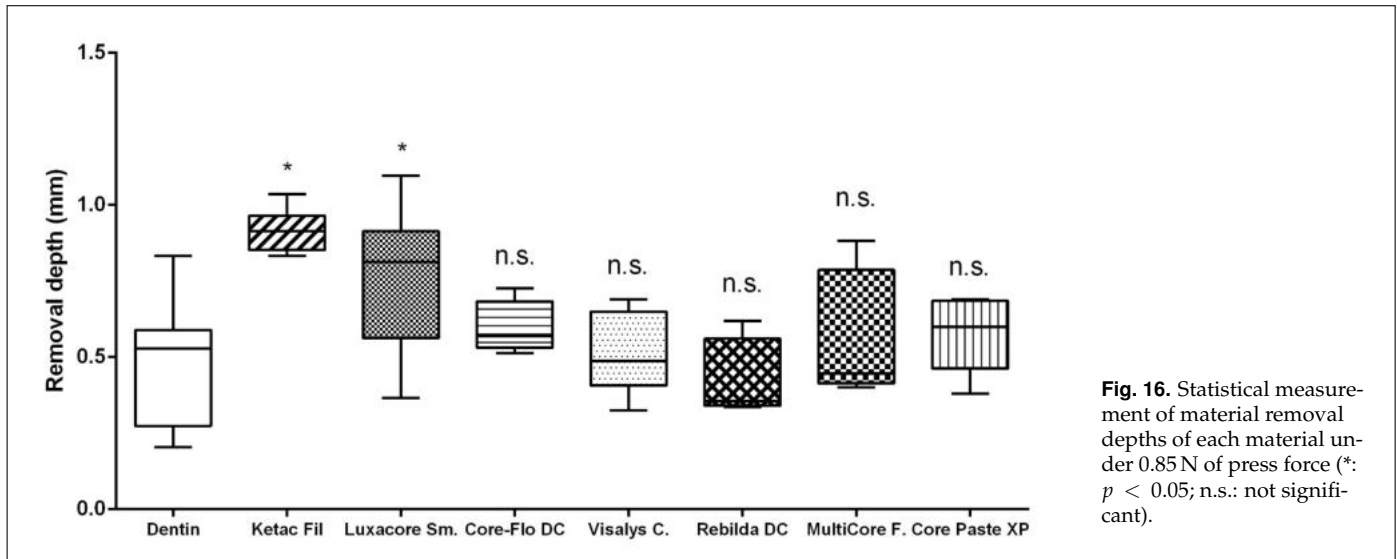

Fig. 16. Statistical measurement of material removal depths of each material under 0.85 N of press force (*: $p < 0.05$; n.s.: not significant).

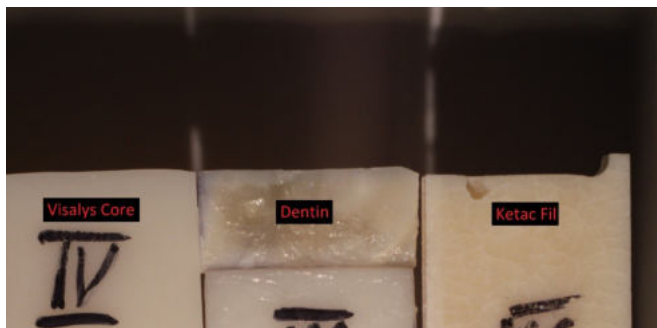

Fig. 17. Removal depths of Visalys Core, dentin and Ketac Fil under 0.85 N of press force.

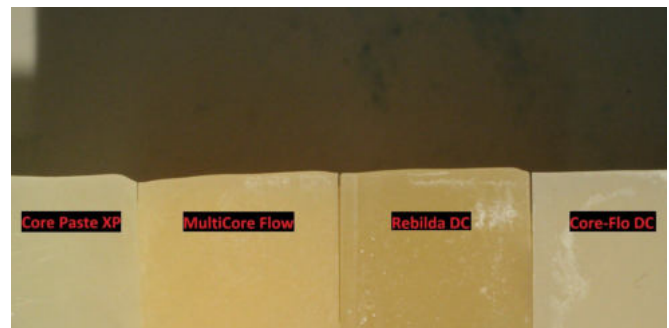

Fig. 19. Removal depths of Core Paste XP, MultiCore Flow, Rebilida DC and Core-Flo DC under 0.85 N of press force.

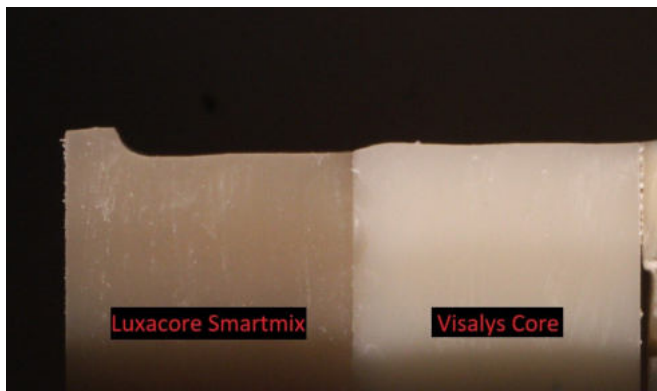

Fig. 18. Removal depth comparison between Luxacore Smartmix and Visalys Core under 0.85 N of press force.

relatively similar generated depths, while Luxacore Smartmix exhibited a significantly greater increase of material removal.

Under 1.2 N press force, material failure took place on Ketac Fil, by which the removal depth was increasing constantly and therefore unmeasurable with this study method. This can be seen on Figure 20. It indicated that the critical press force value to produce a constant removal

depth for Ketac Fil has been surpassed.

Figure 23 shows greater material removal depths of Core-Flo DC compared to Core Paste XP, MultiCore Flow and Rebilida DC under the highest press force tested in this study. Core-Flo DC showed a significant difference to dentin, while Core Paste XP, MultiCore Flow and Rebilida DC maintained their similarity.

As observed in the previous tests with lower press forces (0.5 N and 0.85 N), it was apparent that dentin specimens generally had the lowest removal depths compared to those of composite resins and glass ionomer cement, except Rebilida DC, which indicated a better material resistance to grinding cycles under higher press force (1.2 N), with 0.08 mm less material removal value than that of dentin.

Mean removal depth value comparison

The removal depth's mean value of all specimens under three different press forces are shown on Figure 24.

Under all press forces, dentin specimens constantly exhibited the lowest mean removal depth value compared to the core build-up materials, except Rebilida DC. With constant increase of 0.35 N press force, dentin specimens also showed a relatively constant material removal with

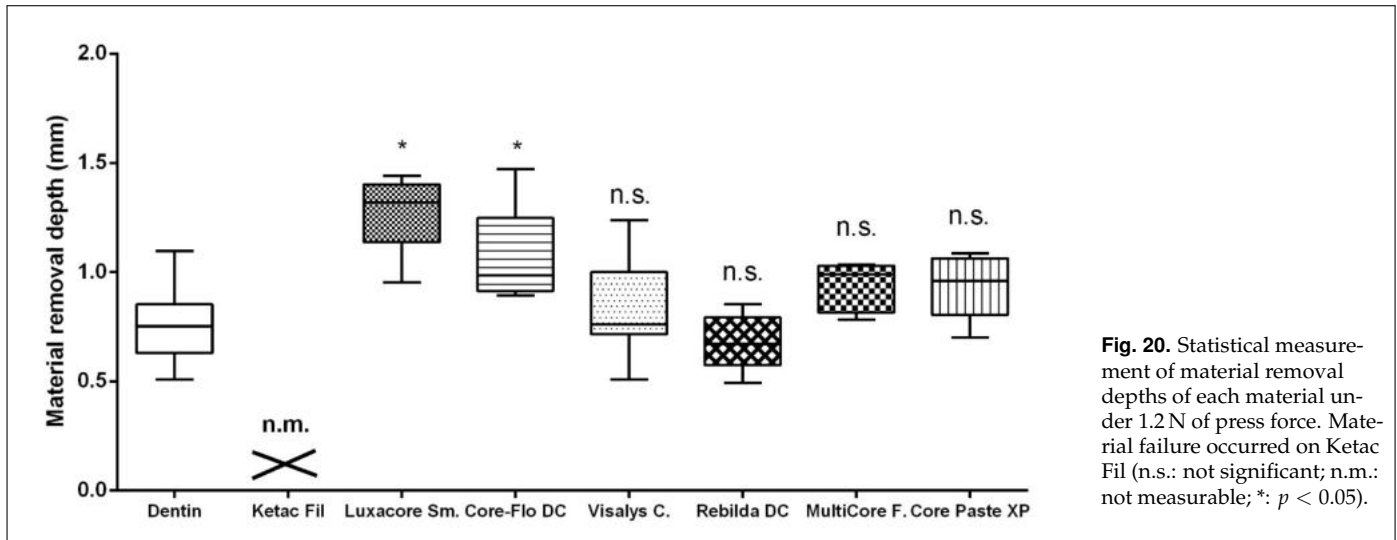

Fig. 20. Statistical measurement of material removal depths of each material under 1.2 N of press force. Material failure occurred on Ketac Fil (n.s.: not significant; n.m.: not measurable; *: $p < 0.05$).

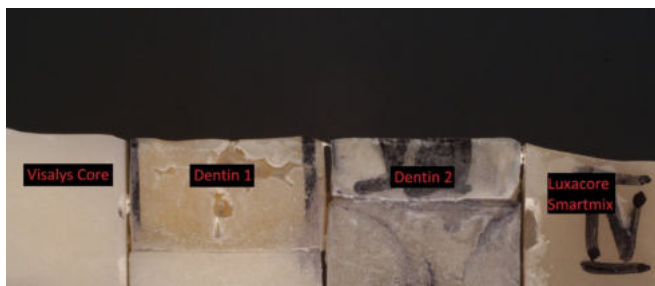

Fig. 21. Removal depths of Visalys Core, two different dentin specimens and Luxacore Smartmix under 1.2 N press force.

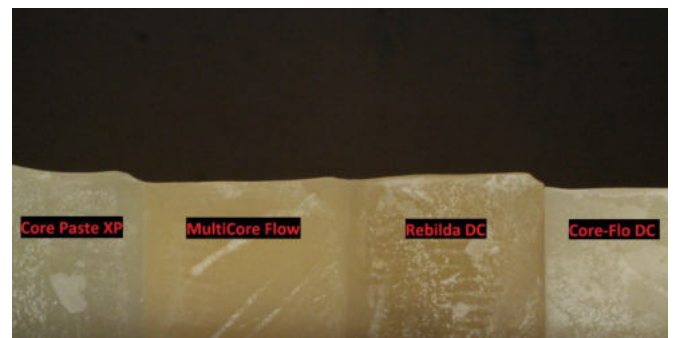

Fig. 23. Removal depths of Core Paste XP, MultiCore Flow, Rebilida DC and Core-Flo DC under 1.2 N press force.

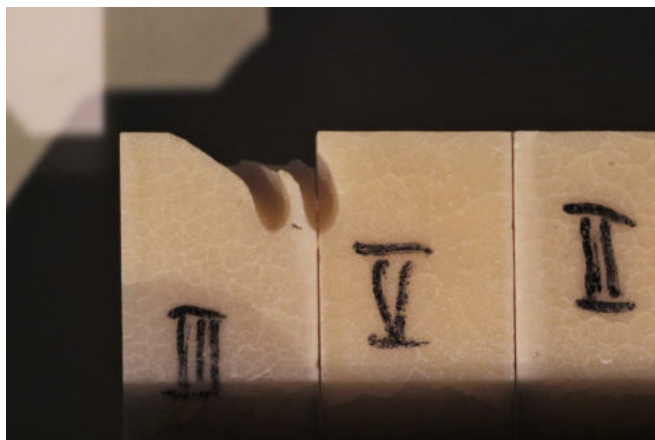

Fig. 22. Material failure on Ketac Fil under 1.2 N press force.

an approximate depth growth of 0.25 mm.

On the other hand, an increase of slope can be observed on the core build-up materials, which expressed a higher amount of growth of material removal when the press force was increased. The gap between the core build-up material's mean values to those of dentin specimens grew after reaching 0.85 N. It is also visible that Rebilida DC has the least material removal compared to dentin specimens and other core build-up materials. Compared

to dentin, Rebilida DC produced a slightly more material removal only under 0.5 N. But also under 0.5 N, Rebilida DC showed the nearest mean value to dentin with only 0.014 mm difference.

Rebilida DC and Visalys Core appeared to have the nearest mean values to those of dentin on each press force, which generated a maximum gap of 0.079 mm and 0.14 mm, respectively. However, Visalys Core showed a better similarity to dentin under 0.85 N with only 0.028 mm of gap. Luxacore Smartmix is the only composite resin that showed a relatively bigger gap to dentin's value, with maximum and minimum gap of 0.51 mm and 0.21 mm, respectively. The minimum gap of Luxacore Smartmix did not reach the maximum gap value of Visalys Core. Core Paste XP and MultiCore Flow showed a very similar material removal development under each press force. The minimum gap Core Paste XP and MultiCore Flow to dentin are 0.092 mm and 0.082 mm, respectively. Core-Flo DC's values are somewhat similar to Core Paste XP and MultiCore Flow under 0.5 N and 0.85 N, but reached a gap of 0.3 mm to when 1.2 N press force was applied, which is significantly different to dentin's value. Ketac Fil exhibited the largest gap to dentin under every press force. Because of the material failure under 1.2 N

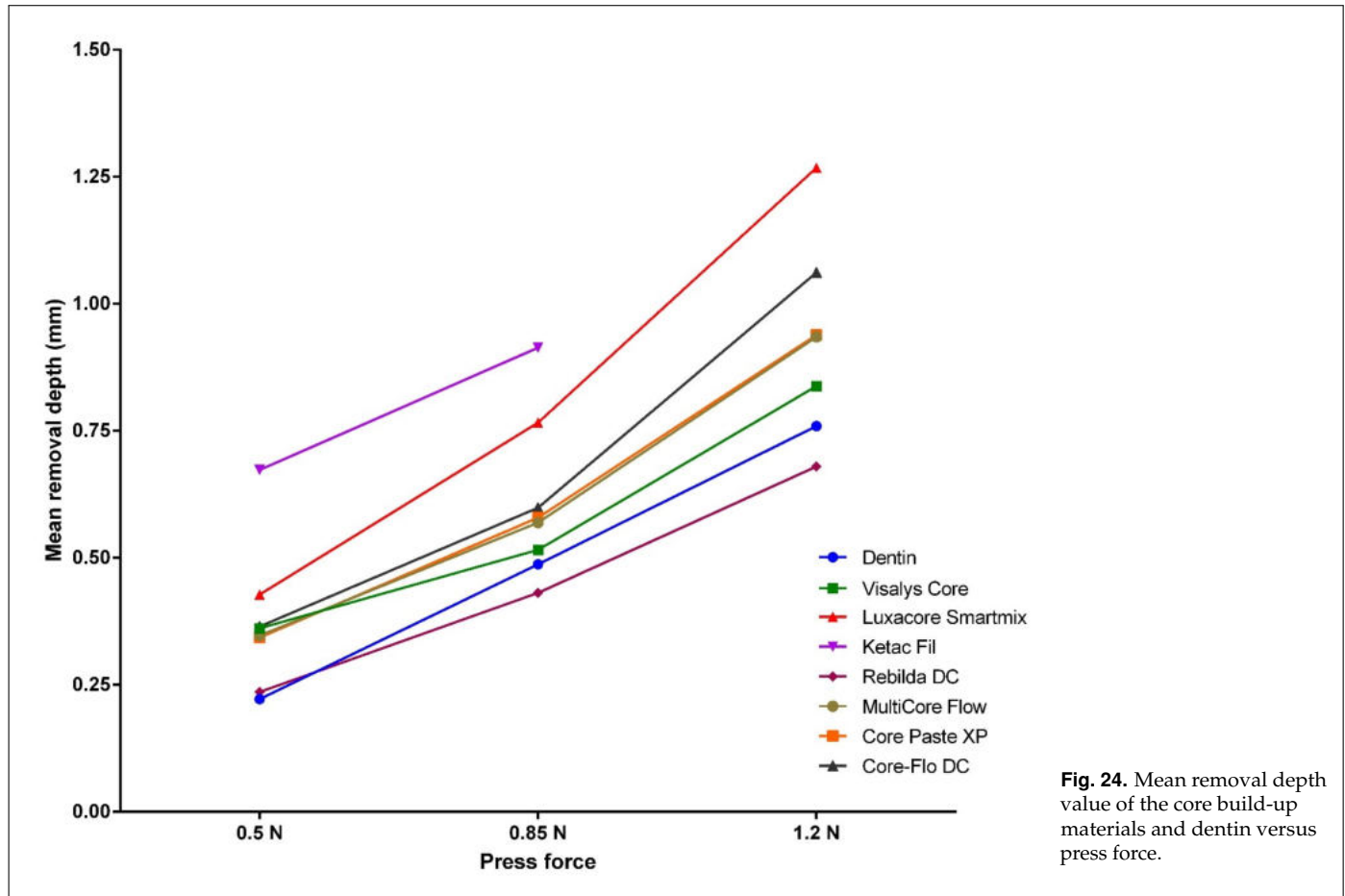

Fig. 24. Mean removal depth value of the core build-up materials and dentin versus press force.

press force, its value cannot be shown on the graph. Ketac Fil also showed a relatively constant gap to dentin under 0.5 N and 0.85 N.

Surface roughness measurement

In this segment, the materials were polished with fine-grit size 46 μm diamond burs, rotating at 150,000 min^{-1} with cutting speed of 1.51 mm/sec, under constant water cooling of 50 ml/min. Each test consists of only one grinding cycle. The tests were conducted under 0.5 N press force.

The surface roughness of dentin and core build-up materials were statistically analyzed and shown on Figure 25 to 30.

The average roughness R_a

Figure 25 shows the results of the average roughness parameter R_a and the significant roughness difference ($p < 0.05$) between the core build-up materials and dentin. The maximum R_a value of 4.27 μm was obtained by Ketac Fil, with 3.14 μm gap from its own mean R_a value of 1.076 μm , which is also the largest mean R_a value compared to dentin and composite resins. The mean R_a value of dentin and the composite resins are all under 0.5 μm . Figure 26 was inserted for better illustration of dentin and composite resins specimens.

The mean R_a value and value distributions of dentin,

Visalys Core and Luxacore Smartmix were relatively congruous. Luxacore Smartmix exhibited better similarity to dentin with mean R_a value of 0.33 μm and 0.34 μm , respectively. The lowest R_a value was obtained by Visalys Core with 0.28 μm . However, the composite resins presented a statistically insignificant difference to dentin.

Five point average roughness R_z

The measurement results of five highest peaks and deepest valleys of the materials revealed a similar characteristics to R_a , but with different magnitude (Figure 27). The highest R_z -value was obtained by Ketac Fil with 34.60 μm , with 10.45 μm as its mean value. This demonstrated a significant difference ($p < 0.05$) to dentin. In contrast to Ketac Fil, the composite resins and dentin had a much lower mean value and value distribution, which is shown on Figure 27.

However, MultiCore Flow, Core Paste XP and Core-Flo DC showed a statistically significant difference to dentin. The statistical measurements of core build-up materials with no significant difference to dentin are shown on Figure 28 for better representation.

With 2.236 μm , Visalys Core demonstrated a highly similar result to dentin's, which possess 2.24 μm as mean R_z -value. Luxacore Smartmix obtained a slightly higher mean R_z -value with 2.786 μm and also had a compara-

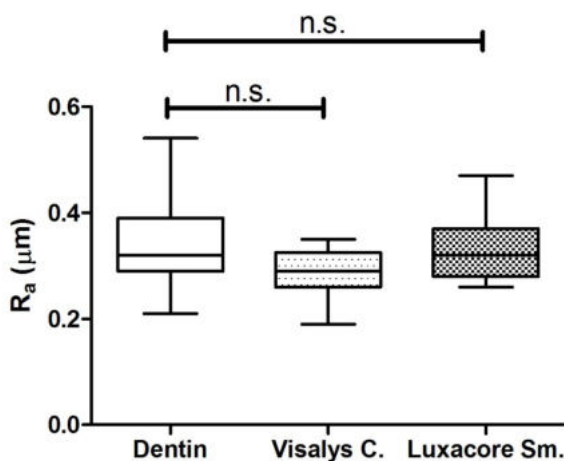
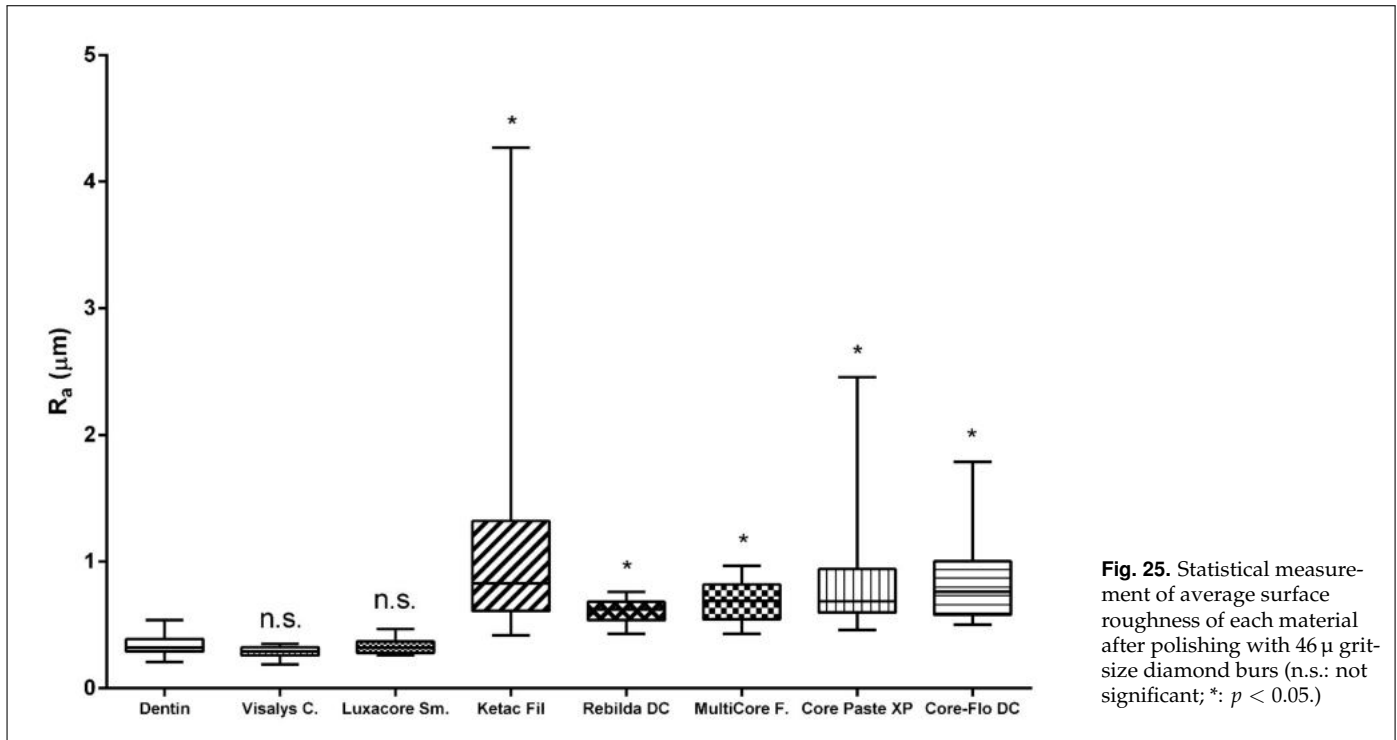

Fig. 26. Enlargement of Figure 25 for better R_a -representation of dentin, Visalys Core and Luxacore Smartmix, which shows statistical measurement of average surface roughness of each material after polishing with 46 μ grit-size diamond burs (n.s.: not significant).

tively tall box plot. Rebuilda DC also possessed a higher mean R_z -value with 3.643 μ m and wider value distribution compared to Visalys Core. Despite these different roughness values, Visalys Core, Luxacore Smartmix and Rebuilda DC exhibited no significant difference to dentin.

Maximum roughness R_{max}

As shown on Figure 29, Ketac Fil had the highest value of maximum roughness at 63.18 μ m and mean R_{max} -value at 20.96 μ m, presenting a significant roughness difference to dentin ($p < 0.05$) and composite resins.

With an approximate amount of 60 μ m, the R_{max} -range of Ketac Fil is roughly ten times greater than that of dentin. Analogous to the R_a - and R_z -measurement, Ketac Fil is the roughest material compared to dentin and composite resins. One composite resin, Core Paste XP, showed a statistically significant difference to dentin with 7.183 μ m as its mean value. Unlike Visalys Core and Luxacore Smartmix, Rebuilda DC, MultiCore Flow and Core-Flo DC obtained mean value above 5 μ m, despite showing no significant difference to dentin's value. The statistical measurements of core build-up materials with no significant difference to dentin are shown on Figure 30 for better representation.

Between the materials with no statistically significant difference to dentin, Luxacore Smartmix, Rebuilda DC and Core-Flo DC showed a relatively greater value distribution, ranging from 20 μ m to 18.43 μ m. Dentin generated the lowest mean value of R_{max} with 3.01 μ m compared to the core build-up materials. Visalys Core obtained the closest mean value to dentin with 3.3 μ m. Luxacore Smartmix, Rebuilda DC, MultiCore Flow and Core-Flo DC possessed mean R_{max} -value of 4.37 μ m, 5.001 μ m, 5.51 μ m and 6.55 μ m, respectively. As seen from both its mean value and value distribution, Visalys Core presented a highly similar characteristic to dentin.

DISCUSSION

Discussion of the study method

To test and analyze the grindability behavior of core build-up materials, this study aimed to simulate clinical conditions by applying the parameters used during

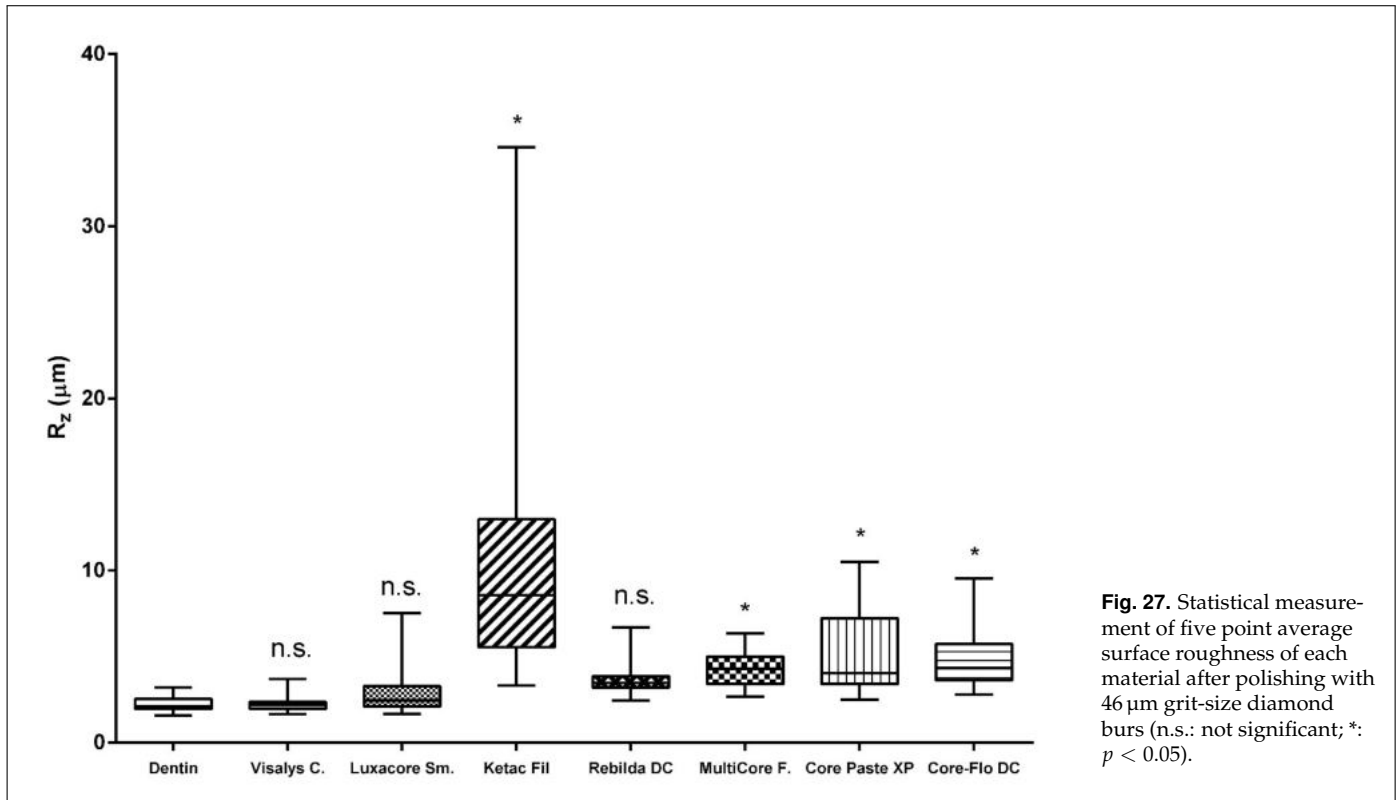

Fig. 27. Statistical measurement of five point average surface roughness of each material after polishing with 46 μm grit-size diamond burs (n.s.: not significant; *: $p < 0.05$).

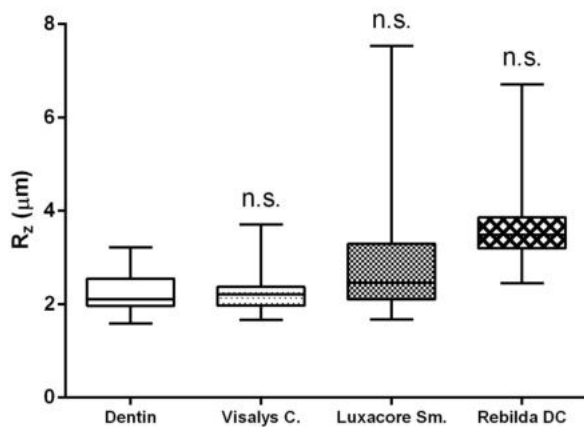

Fig. 28. Enlargement of Figure 27 for better R_z -representation of dentin, Visalys Core, Luxacore Smartmix and Rebilida DC which shows statistical measurement of five point average surface roughness of each material after polished with 46 μm grit-size diamond burs (n.s.: not significant).

dental preparation. However, dentists regularly change the feed rates, press forces and bur speeds depending on the required material removal, the type of hard tissue (i.e. enamel, dentin) and restorative material. To eliminate the differences generated from this matter, constant parameters from various clinical studies were chosen for the experiments.

The study was divided into two experiments/phases, namely, the rough cutting phase and the polishing phase. The first phase was verified by Jung and Pantke (1991)

on their studies [13, 17], that coarse-grit diamond burs should be used to achieve a rapid material removal during dental preparation [17]. Another study from Yin et al. (2007) had suggested, that coarse-grit burs can be used for mass removal of material in which surface quality can be ignored, which is exactly the case in this experiment-phase [35]. For this reason, medium-grit size (106–125 μm) diamond burs were used in this study.

To allow a reliable definitive restoration placement and its steady retention, the core materials need to be polished first to provide the required surface roughness. The polishing bur speed, press force and diamond burs (fine-grit 46 μm) used for polishing in this study correspond with those used in Lasson's study (2005) [17]. The same study claimed the necessity to polish core build-up materials with fine-grit diamond burs before the crown preparation to maintain the similarity of surface roughness to dentin.

Mean cutting speed of 1.51 mm/sec used in this study was taken from a study from Miho et al. (2015), which was obtained by measuring the cutting speeds of 19 dentists with 2 to 19 years of experience in clinical practice [19]. A correlation between rotation speed and press force is known [19]. However, two different studies conducted by Lasson (2005) and Miho et al. (2015) used the same amount of press force but with different rotational speed [17, 19]). Thus, the average bur speed of 200,000 min^{-1} from those studies were generated and used for the rough cutting experiment in this study. This bur speed is also the maximum speed that can be adjusted on the clinical dental chair used in this study.

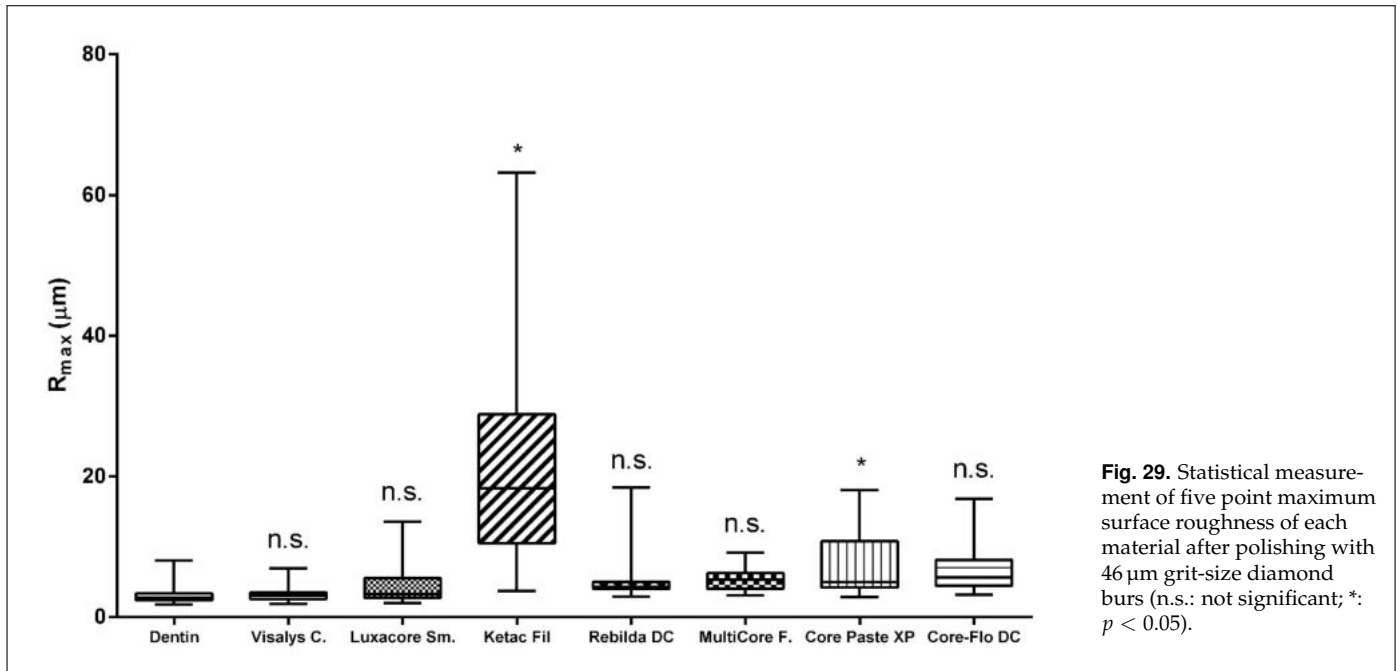

Fig. 29. Statistical measurement of five point maximum surface roughness of each material after polishing with 46 μm grit-size diamond burs (n.s.: not significant; *: $p < 0.05$).

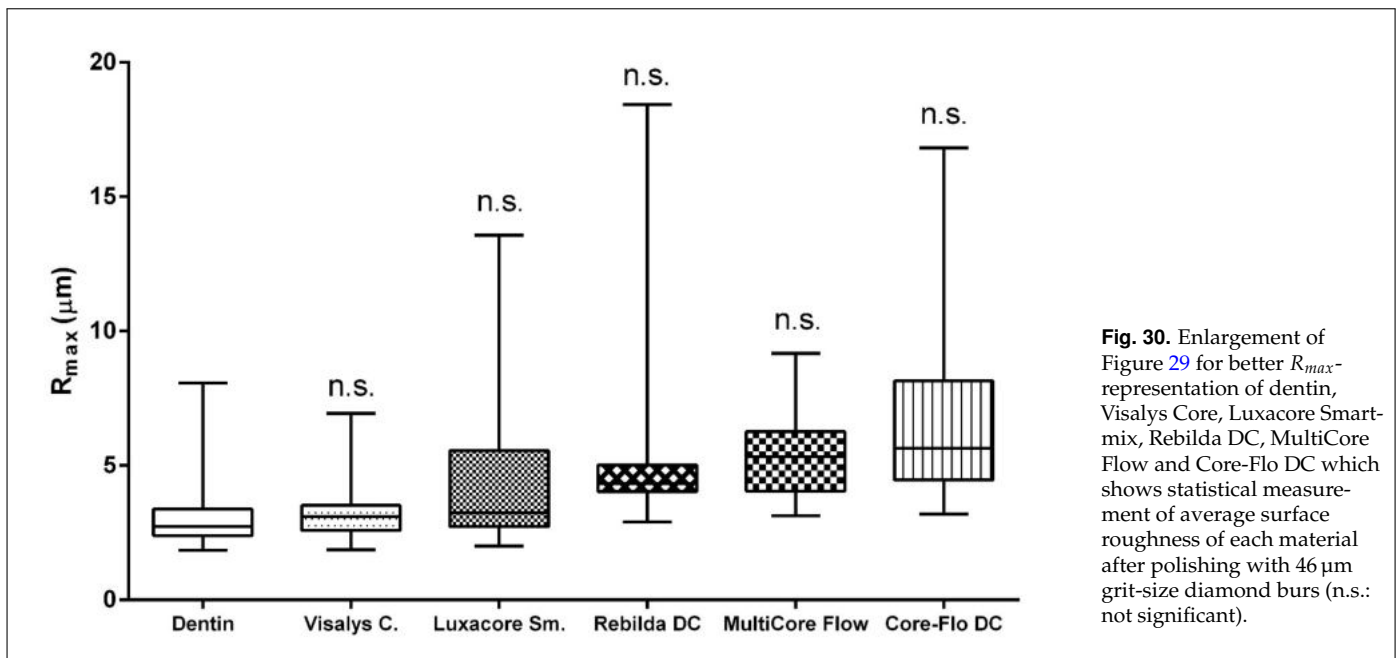

Fig. 30. Enlargement of Figure 29 for better R_{max} -representation of dentin, Visalys Core, Luxacore Smart-mix, Rebuilda DC, MultiCore Flow and Core-Flo DC which shows statistical measurement of average surface roughness of each material after polishing with 46 μm grit-size diamond burs (n.s.: not significant).

One of the most important parameter in this study is the press force. Several recent studies applied 0.5 N as the defined press force [17, 19, 29], which is claimed as a part of an approved procedure and comparable to other studies [17]. However, considering the constantly changed press force during clinical preparation, especially for material removal, this approved procedure was modified in this study. The 0.5 N press force was assumed to be the lowest press force, and higher press forces of 0.85 N and 1.2 N were applied in this study, presuming the case where dentists need to press harder for greater material removal. Moreover, this also provided a better analysis of the material behavior under different press forces during

cutting. It was also approved by Siegel et al. (1996), that the range of 0.5 N–1.5 N are the common loads at the bur tip applied in dental practice [27].

Due to material shrinkage of some of the core build-up materials provided from the manufacturer and imprecision during finishing of the dentin specimens, a gap between the specimens emerged after putting them into the test piece holder (Figure 31), which then contributed to imprecision during cutting and measuring in some cases. Therefore, any gap during cutting has to be avoided on further studies. However, if the gap is smaller than the diameter of the bur, the cutting result can still be measured.

There were some unmeasurable materials in some tests,

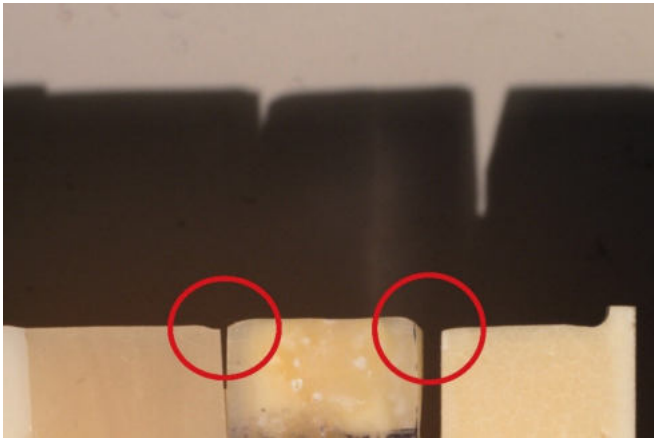

Fig. 31. Gap between the specimens, marked with the red circles, can produce inaccuracy during cutting.

mainly the first cut specimen, where the dental bur movement needs to start simultaneously with the bur rotation. If not, which is sometimes the case in this study, either an unintended material depth on the first specimen will be formed or the bur will enter the second specimen's surface, before it stabilizes itself on the first one. The temporary solution was to repeat the test while changing the material sequence, so that the previously unmeasurable specimen can be grinded once more.

The method used in this study only works when the measured material depths are relatively at constant level. For the materials in this study, press force lower than 0.5 N or higher than 1.2 N will result in uneven material depth, although 1.2 N is already surpassing the press force limit for Ketac Fil, which resulted in increased material removal within the cutting path.

Despite the reproducibility of the study method with all its parameters, further improvement is strongly suggested for prospective studies.

Discussion of the results

Until now, there are unfortunately not enough clinical studies concerning the grindability of core build-up materials and no exact standard requirement for core build-up material are defined [29]. For this reason, clinical studies with dentin as the control group must be performed. The evaluation of the material will then be performed through interpretation of the similarity with dentin. The summary of the statistical analysis results is shown in the Table 5.

Regarding the cutting experiment for material removal and surface polishing, Ketac Fil exhibited the most unfavorable behavior with the largest amount of material removal under every press force and significant differences of surface roughness compared to other core materials and dentin, which was expected. This does confirm other publications that stated GIC's inferiority of mechanical properties in comparison to composite resin. Significant differences to dentin in terms of grindability under changing press forces make GIC an inadequate choice of mate-

Table 5. Summary of the statistical analysis results of the grindability tests (n.s.: not significant; n.m.: not measurable; *: $p < 0.05$).

Material	Press force [N]			Roughness [μm]		
	0.5	0.85	1.2	R_a	R_z	R_{max}
Visalis Core	n.s.	n.s.	n.s.	n.s.	n.s.	n.s.
Rebilda DC	n.s.	n.s.	n.s.	*	n.s.	n.s.
Luxacore Sm.	n.s.	*	*	n.s.	n.s.	n.s.
Core-Flo DC	n.s.	n.s.	*	*	*	n.s.
Core Paste XP	n.s.	n.s.	n.s.	*	*	*
MultiCore Flow	n.s.	n.s.	n.s.	*	*	n.s.
Ketic Fil	*	*	n.m.	*	*	*

rial for core build-up restoration. It can also be concluded, that GIC is only applicable in low-stress areas. Besides the material removal, the surface roughness of Ketac Fil after being polished were also categorized as inadequate because of its significant differences to dentin. An example of Ketac Fil's material failure can be seen on Figure 32.



Fig. 32. Material failure on Ketac Fil test specimen under 1.2 N press force.

Interesting results can be observed on the composite resins, which showed some different behaviors during cutting. In general, all tested composite resins in this study obtained higher material removal depth compared to dentin specimens. Luxacore Smartmix and Core-Flo DC exhibited significant differences to dentin when higher press forces were applied. As the only composite resin that showed a significant difference under 0.85 N, Luxacore Smartmix is considered to be the most vulnerable composite resin compared to the others. However, Luxacore Smartmix obtained better surface roughness by showing the best similarity to dentin along with Visalys Core. Some depth developments of dentin, Visalys Core and Luxacore under different press forces can be identified on Figure 33 and 34. While dentin and Visalys Core maintained their material removal rate under two different press forces, Luxacore Smartmix showed a significant in-

crease of depth.



Fig. 33. Relatively similar material removal of Luxacore Smartmix, Visalys Core and dentin under 0.5 N press force.



Fig. 34. Depth comparison between Visalys Core, dentin and Luxacore Smartmix under 1.2 N press force.

There were no significant differences to be found on Core Paste XP and MultiCore Flow in terms of their material removal depths. However, their surface roughnesses are considered to be relatively insufficient, especially Core Paste XP, which exhibited significant differences to dentin on every surface roughness test. Compared to Core-Flo DC, MultiCore Flow generated more stable value distribution of R_a , R_z and R_{max} .

The material removal depths of MultiCore Flow, Core-Flo DC and Core Paste XP are relatively similar under low and mid press forces, as can be seen on Figure 35 and 36.

The depth of Core-Flo DC increased when higher press



Fig. 35. Depth comparison between MultiCore Flow, Core-Flo DC and Core Paste XP under 0.5 N of press force.

force was applied (Figure 37).

Best dentin-similarity regarding the grindability characteristic and surface roughness were achieved by Visalys

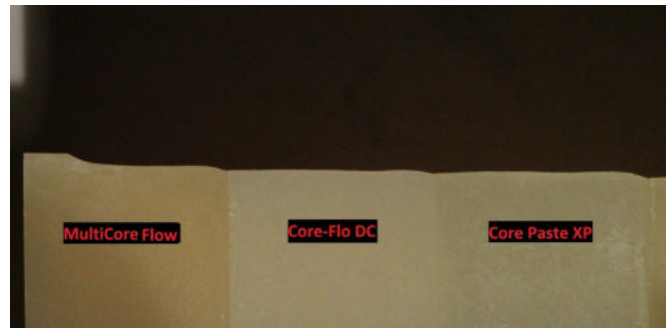

Fig. 36. Depth comparison between MultiCore Flow, Core-Flo DC and Core Paste XP under 0.85 N of press force.

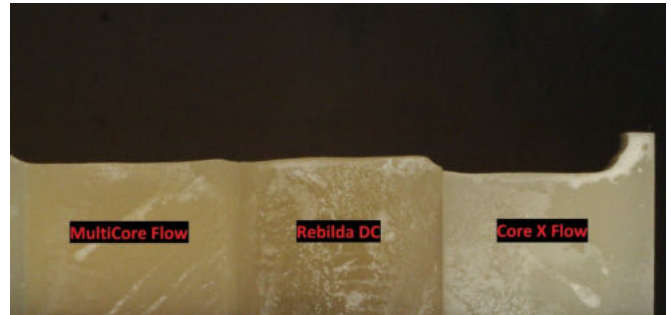

Fig. 37. Depth comparison between MultiCore Flow, Rebuilda DC and Core-Flo DC under 1.2 N of press force.

Core and Rebuilda DC. Visalys Core showed no significant difference to dentin on each grinding test. On the other hand, Rebuilda DC showed one significant difference, namely on the R_a -value. Therefore, it can be concluded that Visalys Core has better surface roughness compared to Rebuilda DC. In terms of material removal, Rebuilda DC exhibited lower material removal depth compared to dentin and Visalys Core. From the statistical measurements of material removal, Rebuilda DC gained a slightly better similarity to dentin compared to Visalys Core and is consequently considered the most stable core build-up material tested in this study.

However, Rebuilda DC exhibited an inhomogeneous composite structure, which consequently generated an uneven surface during grinding process. Even in some cases, the structure of Rebuilda DC is porous, resulting in an inhomogeneous load distribution and consequently undesired material removal depth. These cases can be seen on Figure 38 and 39.

Due to the inhomogeneous nature and porous structure of Rebuilda DC, Visalys Core is favored to be the material of choice as core material regarding its grindability behavior. The conclusion of the results can be seen on the Table 6.

The physical characteristics of the material such as hardness, flexural strength, tensile modulus, compressive strength and thermal expansion determine the grindability behavior of core build-up materials [29]. Therefore, the chemical composition of the material and its chemical bond should be brought to attention, for example the quality of the bond between inorganic fillers and organic

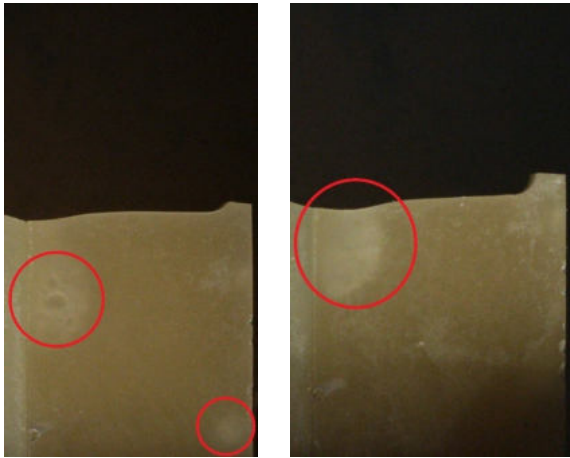

Fig. 38. Inhomogeneous structures of Rebilda DC are marked with red circles.

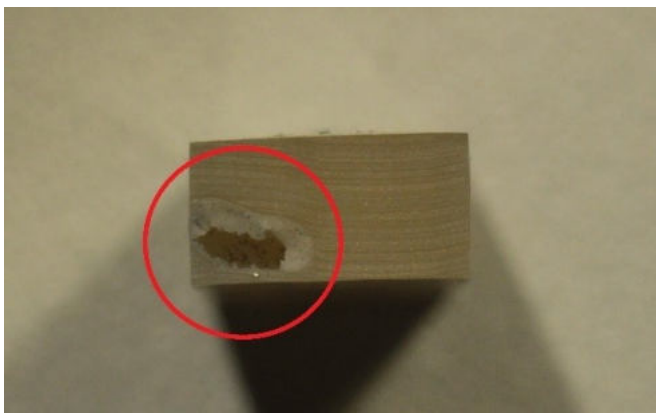

Fig. 39. Porous structure of Rebilda DC is marked with the red circle, photographed from above.

Table 6. Valuation of the core build-up materials tested in this study regarding their grindability behavior (material removal depth), surface roughness and homogeneity.

Core build-up material	Grindability behavior	Surface roughness	Homogeneity
Visalys Core	sufficient	sufficient	sufficient
Rebilda DC	sufficient	significant difference only on R_a -value	insufficient
Luxacore Smartmix	insufficient under higher press forces (> 0.5 N)	sufficient	sufficient
Core-Flo DC	insufficient under higher press forces (> 0.85 N)	insufficient	sufficient
Core Paste XP	sufficient	insufficient	sufficient
MultiCore Flow	sufficient	insufficient	sufficient
Ketac Fil	insufficient	insufficient	sufficient

polymers in composite resin, its filler content as well as the filler size. Compared to Luxacore Smartmix with 49 vol %, Visalys Core has a lower filler content with 42 vol % and also showed a better grindability characteristic. However, Rebilda DC has a higher filler content with 57 vol % compared to other composite resins and showed its superiority in terms of hardness, considering its lowest material removal depths value. It can be concluded that filler content alone can't determine the quality of grindability characteristics of core build-up material. An interesting comparison can be found between MultiCore Flow and Visalys Core. Despite their similarity of filler content and filler size, their grindability characteristics are somewhat different. MultiCore Flow and Visalys Core has 46 vol % of 0.04–25 μm , and 42 vol % of 0.2–20 μm filler content, respectively. The smaller fillers size of Luxacore Smartmix (0.02–2.4 μm) are also expected to exhibit more similarity of surface roughness to dentin than Visalys Core that has 0.2–20 μm of filler size, which was not the case. For this reason, the polymer component and chemical bond between fillers and polymers arguably play a significant role to provide better grindability behavior and similarity to dentin. The intrinsic adhesion connector in Visalys Core (ACT: Active Connect Technology) is presumably an important factor that provides better chemical bond strength between its fillers and the polymer matrix. Unfortunately, there is not enough information regarding the material composition provided by the manufacturers (especially for Core-Flo DC and Core Paste XP), so that further observation and analysis of the material cannot be performed.

Acknowledgement

I would like to thank my supervisor Prof. Dr. Jürgen Geis-Gerstorfer for his valuable guidance, encouragement and thoroughly assistance for this research. I am also thankful to PD Dr. Ashraf ElAyouti (Department of Operative Dentistry and Periodontology, University Hospital Tübingen), who provided insight that greatly improved the research methodology. Lastly, I would like to thank Günter Wendenig and Christine Schille for their technical assistance during the early phase of the research.

BIBLIOGRAPHY

- [1] Anusavice, K. J., Shen, C. and Rawls, H. R. [2013]. *Phillips' Science of Dental Materials*, Elsevier Health Sciences.
- [2] Badawy, R. [2011]. *Selected properties of core-buildup materials for prosthetic restorations*, Thesis, Justus-Liebig-Universität Giessen, Germany.
- [3] Bitter, K., Gläser, C., Neumann, K., Blunck, U. and Frankenberger, R. [2014]. Analysis of resin-dentin interface morphology and bond strength evaluation of core materials for one stage post-endodontic restorations, *PLoS One* 9(2): e86294.
- [4] Bullard, R. H., Leinfelder, K. F. and Russell, C. M. [1988]. Effect of coefficient of thermal expansion on microleakage, *The Journal of the American Dental Association* 116(7): 871–874.
- [5] Cho, G. C., Kaneko, L. M., Donovan, T. E. and White, S. N. [1999]. Diametral and compressive strength of dental core materials, *The Journal of Prosthetic Dentistry* 82(3): 272–276.

- [6] Coury, T., Willer, R., Miranda, F. and Probst, R. [1982]. Adhesiveness of glass-ionomer cement to enamel and dentin: a laboratory study, *Operative Dentistry* 7(1): 2.
- [7] Da Silva, R. C., Zuanon, A. C. C., Spolidorio, D. M. P. and Campos, J. A. D. B. [2007]. Antibacterial activity of four glass ionomer cements used in atraumatic restorative treatment, *Journal of Materials Science: Materials in Medicine* 18(9): 1859–1862.
- [8] Ferracane, J. L. [1995]. Current trends in dental composites, *Critical Reviews in Oral Biology and Medicine* 6(4): 302–318.
- [9] Furtos, G., Baldea, B., Silaghi-Dumitrescu, L., Moldovan, M., Prejmorean, C. and Nica, L. [2012]. Influence of inorganic filler content on the radiopacity of dental resin cements, *Dental Materials Journal* 31(2): 266–272.
- [10] Hickel, R., Dasch, W., Janda, R., Tyas, M. and Anusavice, K. [1998]. New direct restorative materials, *International Dental Journal* 48(1): 3–16.
- [11] Hübel, S. and Mejare, I. [2003]. Conventional versus resin-modified glass-ionomer cement for class ii restorations in primary molars. a 3-year clinical study, *International Journal of Paediatric Dentistry* 13(1): 2–8.
- [12] Ilie, N. and Hickel, R. [2011]. Resin composite restorative materials, *Australian Dental Journal* 56(s1): 59–66.
- [13] Jung, M. and Pantke, H. [1991]. The effect of diamond abrasive bodies of different grain on the tooth hard substance (in german: Die wirkung von diamantschleifkörpern unterschiedlicher körnung auf die zahnhartsubstanz), *Dtsch Stomatol* 41: 320–322.
- [14] Kleverlaan, C. J., van Duinen, R. N. and Feilzer, A. J. [2004]. Mechanical properties of glass ionomer cements affected by curing methods, *Dental Materials* 20(1): 45–50.
- [15] Kurtzman, G. M. and Strassler, H. E. [2006]. Provisional fixed restorations, *Dental Economics* 3: 1–12.
- [16] Lang, B., Jaarda, M. and Wang, R. [1992]. Filler particle size and composite resin classification systems, *Journal of Oral Rehabilitation* 19(6): 569–584.
- [17] Lasson, I. [2005]. *Mechanical properties of different core build-up materials (in German: Mechanische Eigenschaften verschiedener Aufbaumaterialien)*, Thesis, Universitätsklinikum Hamburg-Eppendorf, Germany.
- [18] Marxkors, R., Meiners, H. and Geis-Gerstorfer, J. [2008]. *Textbook of the dental material science (in German: Taschenbuch der zahnärztlichen Werkstoffkunde)*, Deutscher Ärzteverlag.
- [19] Miho, O., Sato, T. and Matsukubo, T. [2015]. Grinding efficiency of abutment tooth with both dentin and core composite resin on axial plane, *The Bulletin of Tokyo Dental College* 56(1): 9–23.
- [20] Miyawaki, H., Taira, M. and Yamaki, M. [1996]. Cutting effectiveness of diamond points on commercial core composite resins and cements, *Journal of Oral Rehabilitation* 23(6): 409–415.
- [21] O'Keefe, K. L. and Powers, J. M. [2001]. Adhesion of resin composite core materials to dentin, *International Journal of Prosthodontics* 14(5): 451–456.
- [22] O'Mahony, A. and Spencer, P. [1999]. Core build-up materials and techniques, *Journal of the Irish Dental Association* 45(3): 8490.
- [23] Rzanny, A., Welker, D., Gomolka, M. and Küpper, H. [2002]. Composite-based core build-up materials - an improvement (in german: Stumpfaufbaumaterialien auf kompositbasis - eine verbesserung), *Dtsch Zahnarzt Z* 57: 550–553.
- [24] Sadek, F. T., Monticelli, F., Goracci, C., Tay, F. R., Cardoso, P. E. and Ferrari, M. [2007]. Bond strength performance of different resin composites used as core materials around fiber posts, *Dental Materials* 23(1): 95–99.
- [25] Schmage, P., Nergiz, I., Sito, F. and Rosentritt, M. [2012]. Preparation time and surface roughness of core foundation resins and dentin, *The Journal of Prosthetic Dentistry* 108(4): 244–249.
- [26] Shebl, E., Etman, W., Genaid, T. M. and Shalaby, M. [2015]. Durability of bond strength of glass-ionomers to enamel, *Tanta Dental Journal* 12(1): 16–27.
- [27] Siegel, S. C. and Fraunhofer, J. v. [1997]. Effect of handpiece load on the cutting efficiency of dental burs, *Machining Science and Technology* 1(1): 1–13.
- [28] Sindel, J., Frankenberger, R., Krämer, N. and Petschelt, A. [1999]. Crack formation of all-ceramic crowns dependent on different core build-up and luting materials, *Journal of dentistry* 27(3): 175–181.
- [29] Sito, F. [2008]. *Properties of composites for core build-up in terms of wear and grindability (in German: Eigenschaften von Kompositen zum Stumpfaufbau hinsichtlich Verschleiss und Beschleifbarkeit)*, Thesis, Universitätsklinikum Hamburg-Eppendorf, Germany.
- [30] Stamatacos, C. and Simon, J. [2013]. Cementation of indirect restorations: an overview of resin cements, *Compendium of Continuing Education in Dentistry (Jamesburg, NJ: 1995)* 34(1): 42–46.
- [31] Vaderhobli, R. M. [2011]. Advances in dental materials, *Dental Clinics of North America* 55(3): 619–625.
- [32] Van Noort, R. and Barbour, M. E. [2013]. *Introduction to Dental Materials*, Elsevier Health Sciences.
- [33] Wegehaupt, F. J., Betschart, J. and Attin, T. [2010]. Effect of sodium hypochlorite contamination on microhardness of dental core build-up materials, *Dental Materials Journal* 29(4): 469–474.
- [34] Xie, D., Brantley, W., Culbertson, B. and Wang, G. [2000]. Mechanical properties and microstructures of glass-ionomer cements, *Dental Materials* 16(2): 129–138.
- [35] Yin, L., Han, Y.-G., Song, X.-F. and Wang, H. [2007]. Effect of diamond burs on process and damage involving in vitro dental resurfacing of a restorative porcelain, *Journal of Physics D: Applied Physics* 40(17): 5291–5300.

AUTHOR BIOGRAPHIES



Tengku Ibrahim Maulana studied medical engineering at the University of Tübingen from 2012–2016 and is currently a medical engineering post-graduate student at the University of Stuttgart. His interests include biomaterials, medical devices and 3D-printing for medical use.

© 2017 by the authors. This is an open access article distributed in accordance with the Creative Commons Attribution Non Commercial (CC BY-NC 4.0) license, which permits others to distribute, remix, adapt, build upon this work non-commercially, and license their derivative works on different terms, provided the original work is properly cited and the use is non-commercial. See: <http://creativecommons.org/licenses/by-nc/4.0>.

